

Chapter 1

Introduction

A note on the use of these PowerPoint slides:

We're making these slides freely available to all (faculty, students, readers). They're in PowerPoint form so you see the animations; and can add, modify, and delete slides (including this one) and slide content to suit your needs. They obviously represent a *lot* of work on our part.

In return for use, we only ask the following:

- If you use these slides (e.g., in a class) that you mention their source (after all, we'd like people to use our book!)
- If you post any slides on a www site, that you note that they are adapted from (or perhaps identical to) our slides, and note our copyright of this material.

For a revision history, see the slide note for this page.

Thanks and enjoy! JFK/KWR

All material copyright 1996-2020
J.F Kurose and K.W. Ross, All Rights Reserved

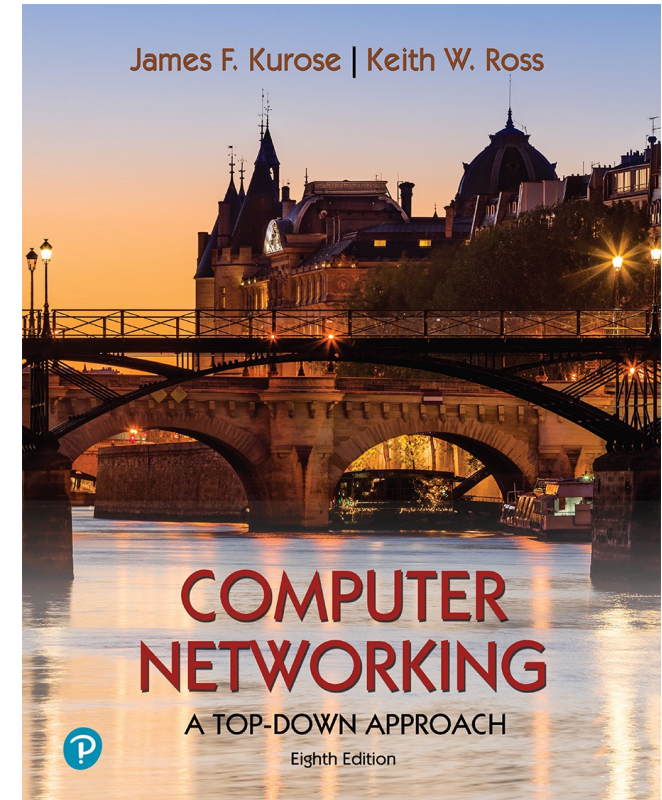

Computer Networking: A Top-Down Approach

8th edition

Jim Kurose, Keith Ross
Pearson, 2020

Chapter 1: introduction

Chapter goal:

- Get “feel,” “big picture,” introduction to terminology
 - more depth, detail *later* in course



Overview/roadmap:

- What *is* the Internet? What *is* a protocol?
- **Network edge:** hosts, access network, physical media
- **Network core:** packet/circuit switching, internet structure
- **Performance:** loss, delay, throughput
- Protocol layers, service models
- Security
- History

The Internet: a “nuts and bolts” view



Billions of connected computing *devices*:

- *hosts* = end systems
- running *network apps* at Internet’s “edge”

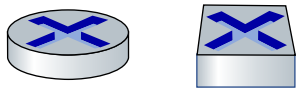

Packet switches: forward packets (chunks of data)

- *routers, switches*



Communication links

- fiber, copper, radio, satellite
- transmission rate: *bandwidth*



Networks

- collection of devices, routers, links: managed by an organization

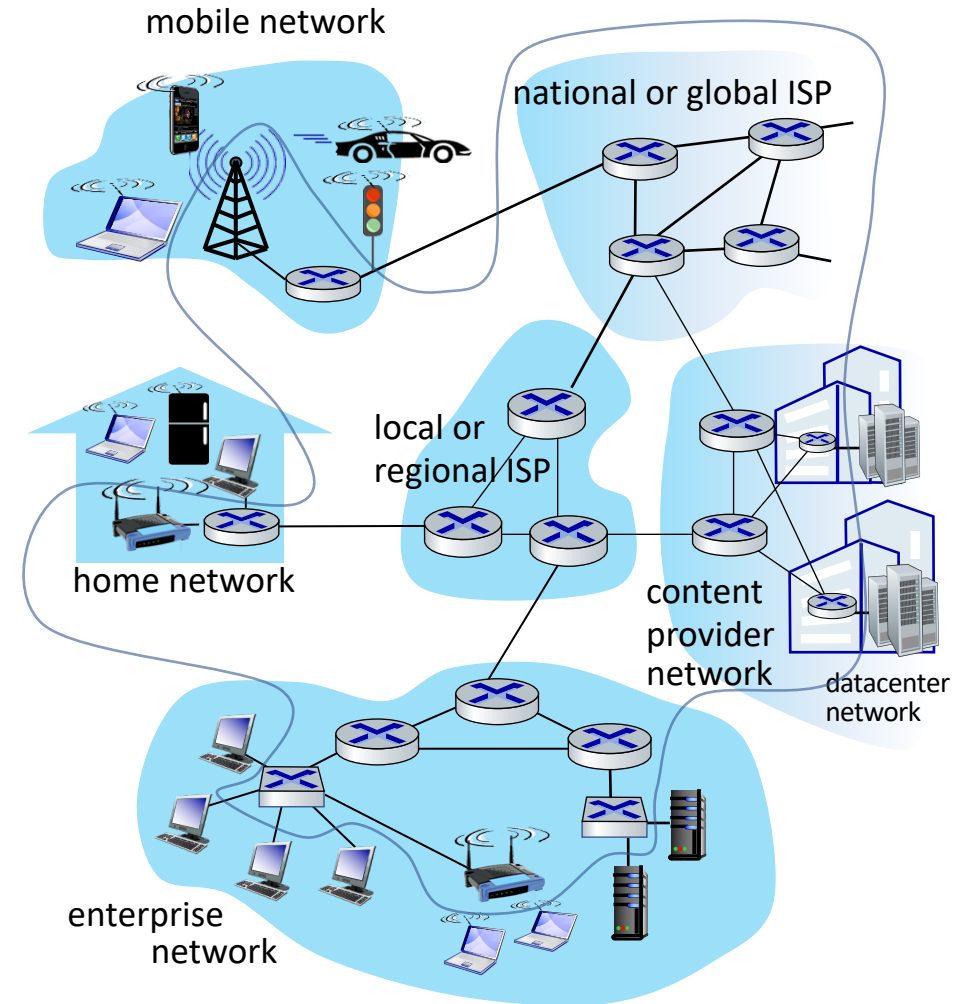

“Fun” Internet-connected devices



Amazon Echo



Internet refrigerator



IP picture frame



Pacemaker & Monitor



Tweet-a-watt:
monitor energy use



Security Camera



Slingbox: remote control cable TV



Web-enabled toaster +
weather forecaster



AR devices



cars



bikes



scooters



Internet phones



Gaming devices



sensorized,
bed
mattress



Fitbit

Others?

The Internet: a “nuts and bolts” view

- *Internet: “network of networks”*
 - Interconnected ISPs
- *protocols are everywhere*
 - control sending, receiving of messages
 - e.g., HTTP (Web), streaming video, Skype, TCP, IP, WiFi, 4G, Ethernet
- *Internet standards*
 - RFC: Request for Comments
 - IETF: Internet Engineering Task Force

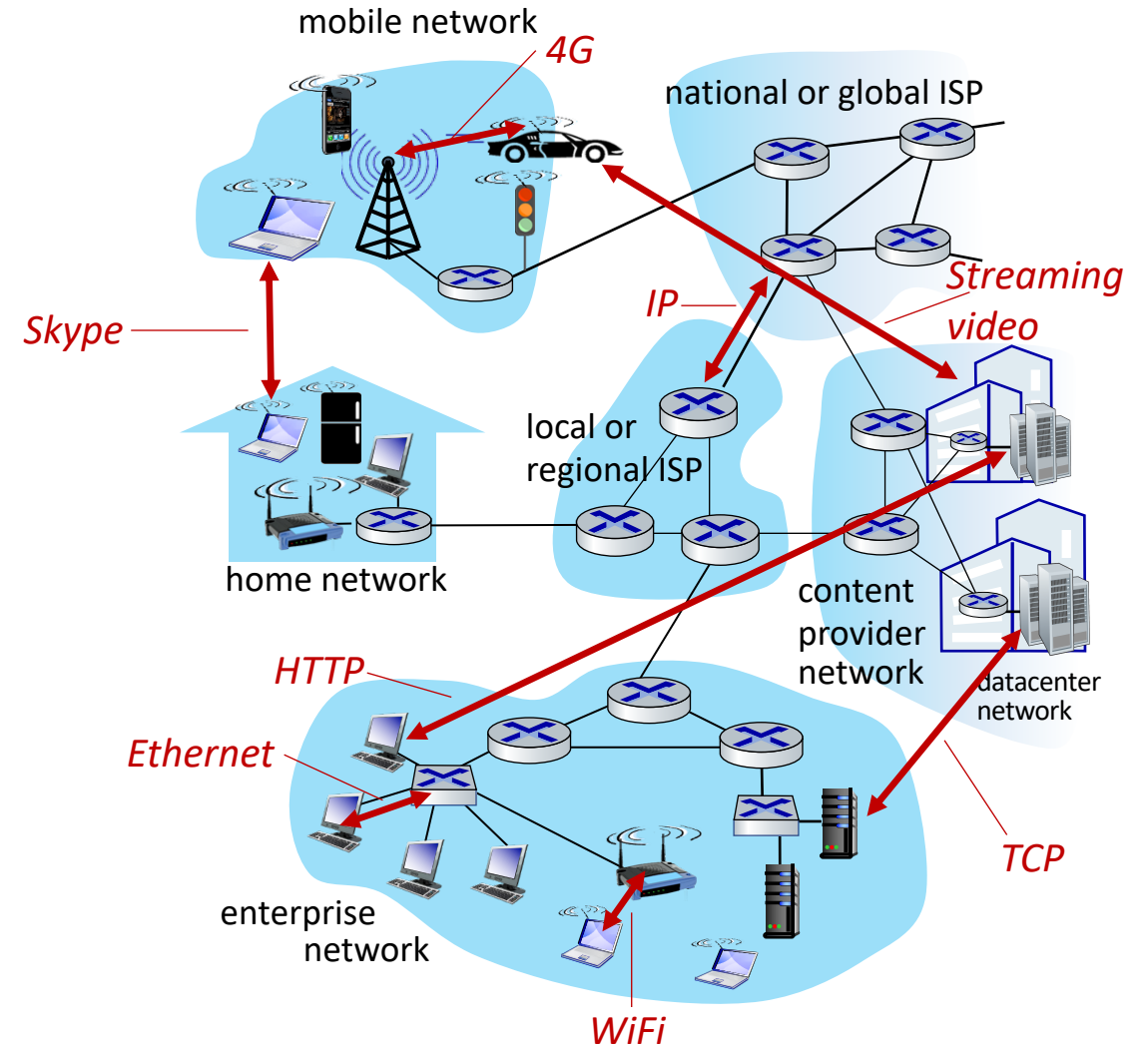

The Internet: a “services” view

- *Infrastructure* that provides services to applications:
 - Web, streaming video, multimedia teleconferencing, email, games, e-commerce, social media, inter-connected appliances, ...
- provides *programming interface* to distributed applications:
 - “hooks” allowing sending/receiving apps to “connect” to, use Internet transport service
 - provides service options, analogous to postal service

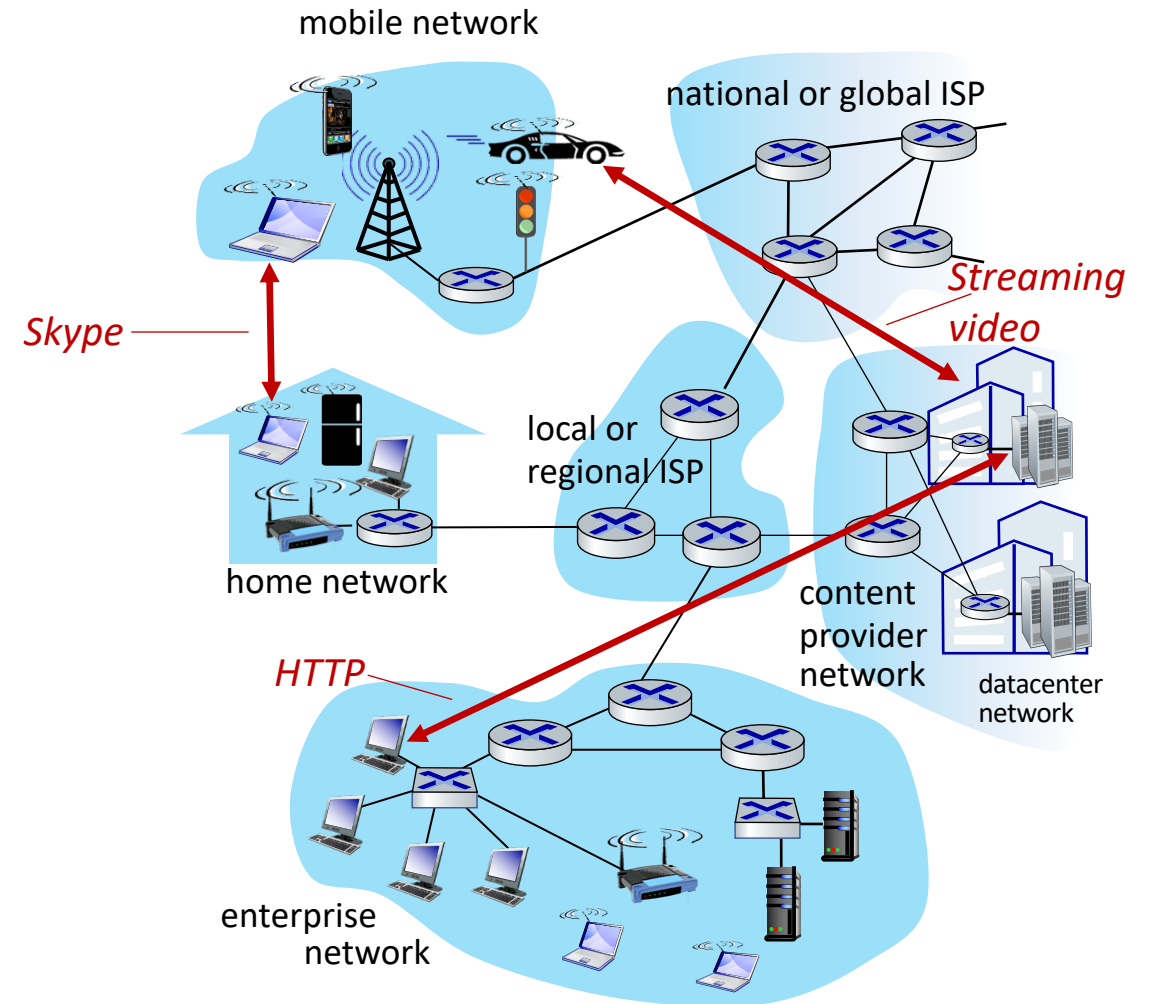

What's a protocol?

Human protocols:

- “what’s the time?”
- “I have a question”
- introductions

Rules for:

- ... specific messages sent
- ... specific actions taken when message received, or other events

Network protocols:

- computers (devices) rather than humans
- all communication activity in Internet governed by protocols

Protocols define the format, order of messages sent and received among network entities, and actions taken on message transmission, receipt

What's a protocol?

A human protocol and a computer network protocol:

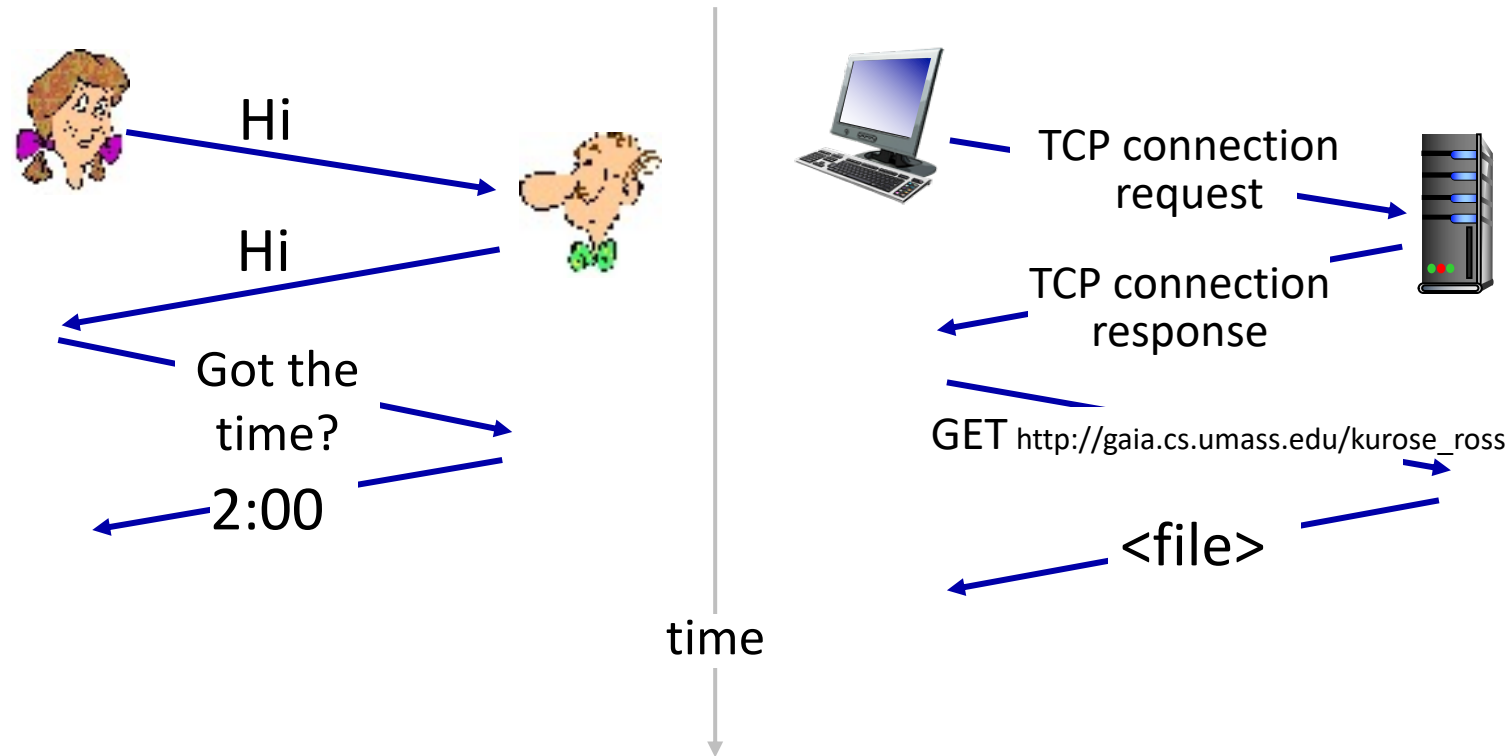

Q: other human protocols?

Chapter 1: roadmap

- What *is* the Internet?
- What *is* a protocol?
- **Network edge:** hosts, access network, physical media
- Network core: packet/circuit switching, internet structure
- Performance: loss, delay, throughput
- Security
- Protocol layers, service models
- History



A closer look at Internet structure

Network edge:

- hosts: clients and servers
- servers often in data centers

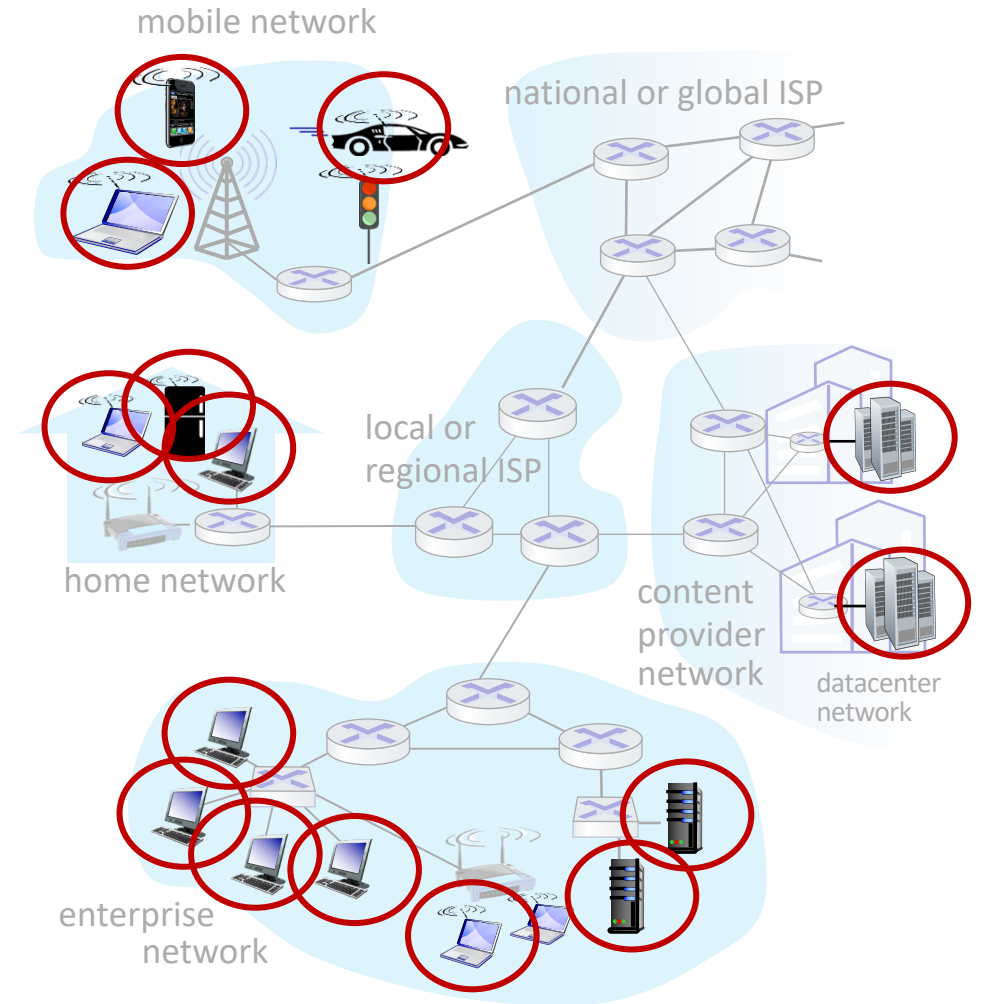

A closer look at Internet structure

Network edge:

- hosts: clients and servers
- servers often in data centers

Access networks, physical media:

- wired, wireless communication links

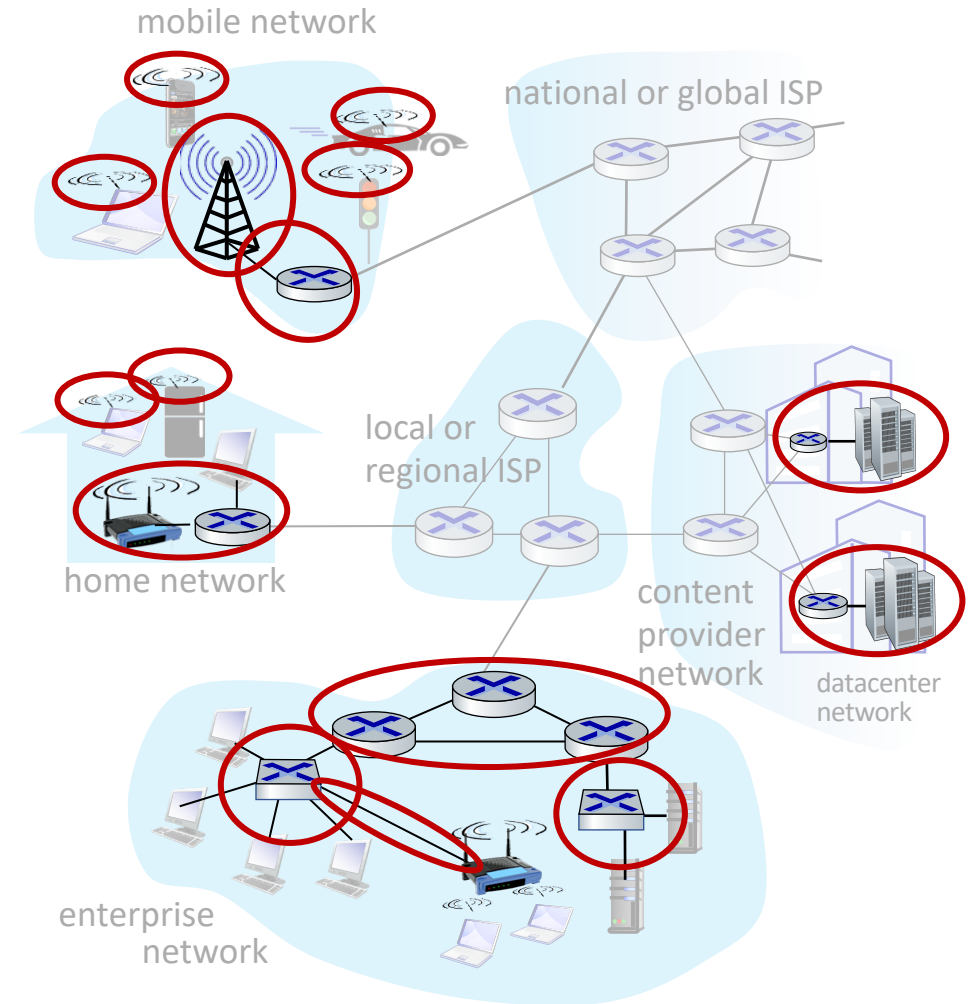

A closer look at Internet structure

Network edge:

- hosts: clients and servers
- servers often in data centers

Access networks, physical media:

- wired, wireless communication links

Network core:

- interconnected routers
- network of networks

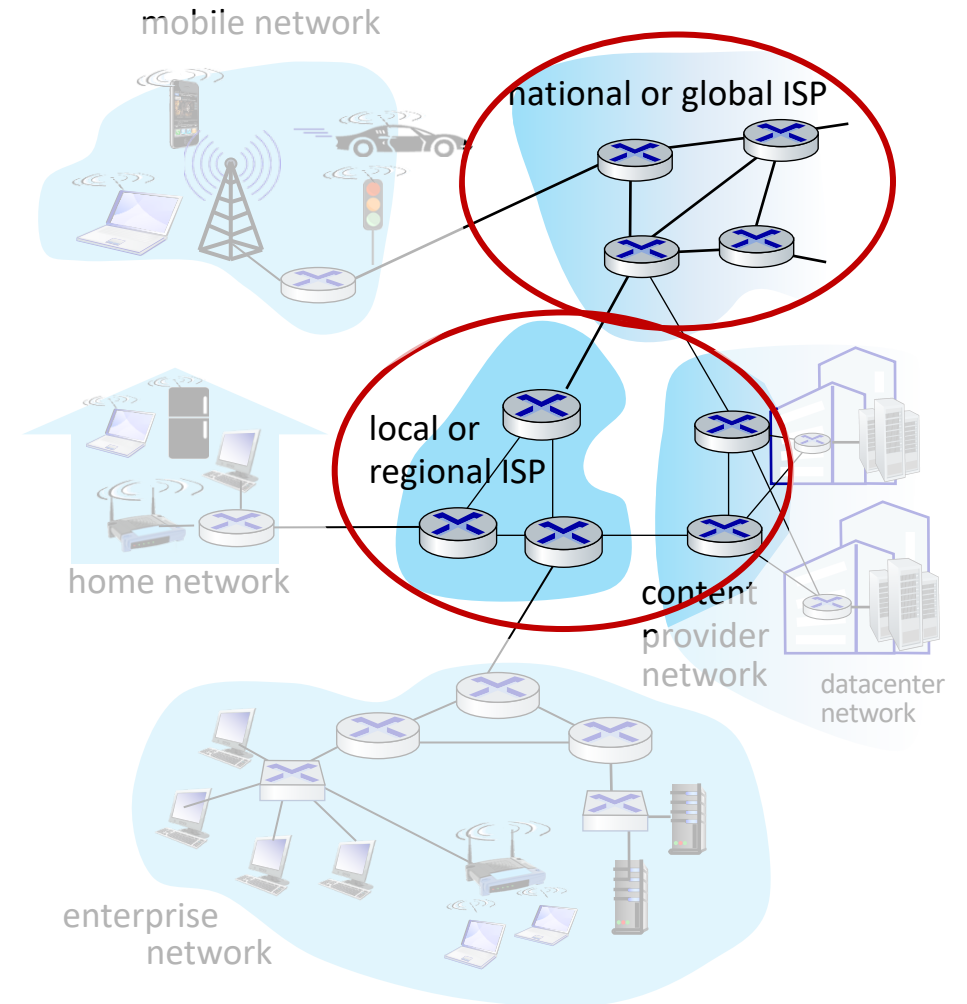

Access networks and physical media

Q: How to connect end systems to edge router?

- residential access nets
- institutional access networks (school, company)
- mobile access networks (WiFi, 4G/5G)

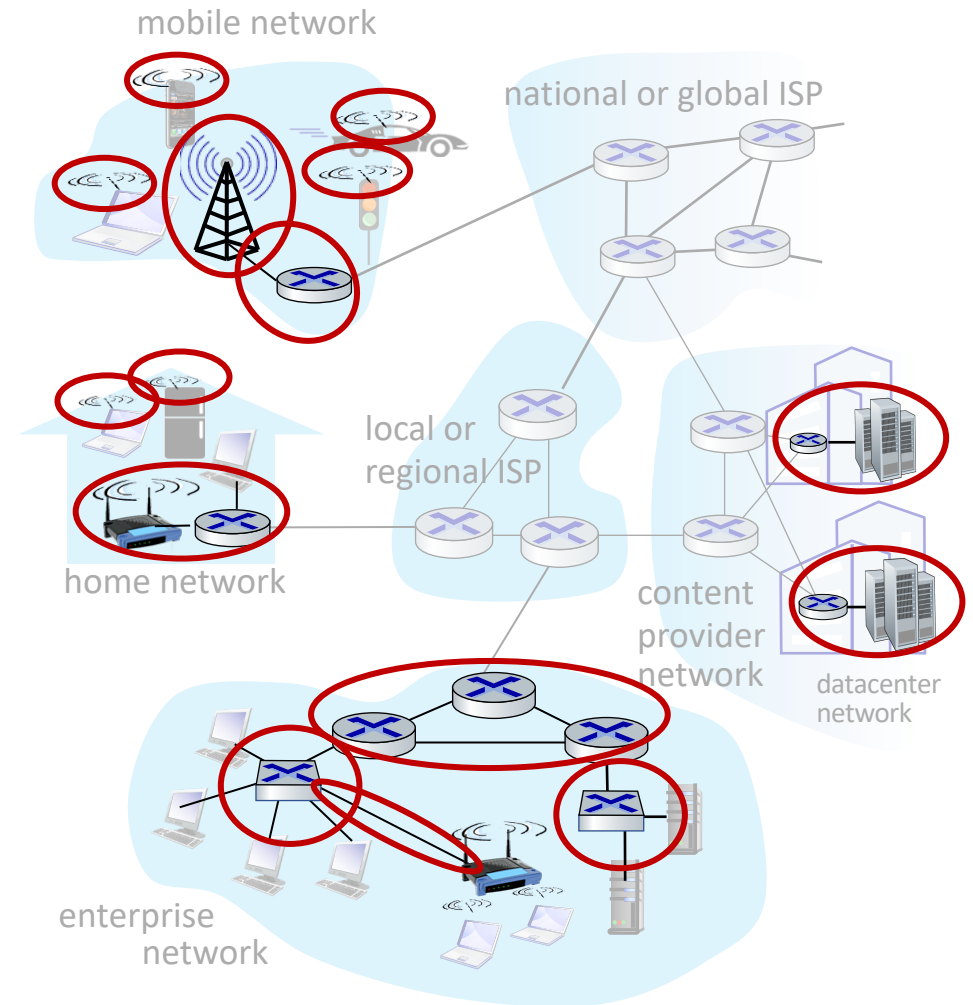

Access networks: cable-based access

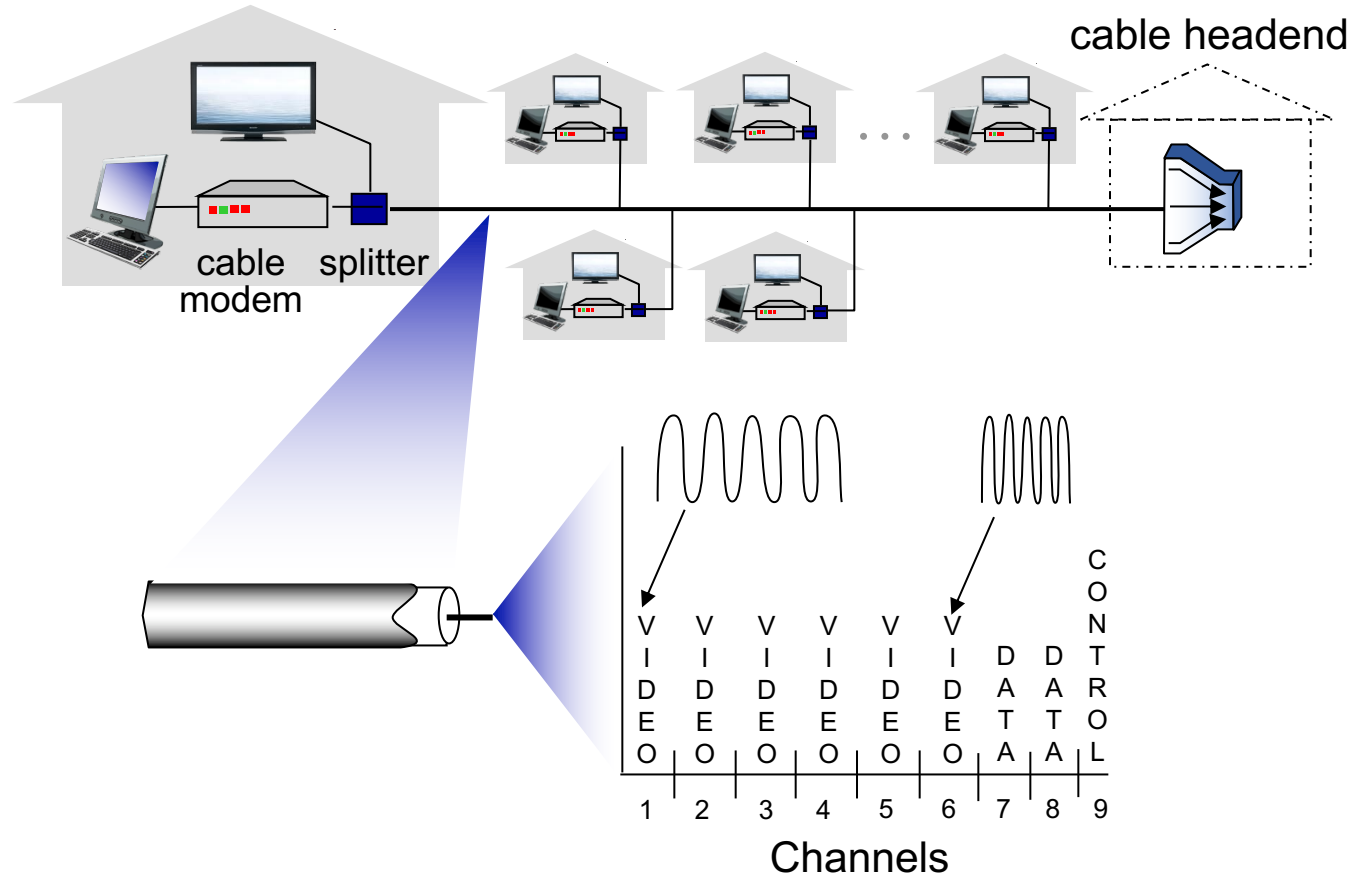

frequency division multiplexing (FDM): different channels transmitted in different frequency bands

Access networks: cable-based access

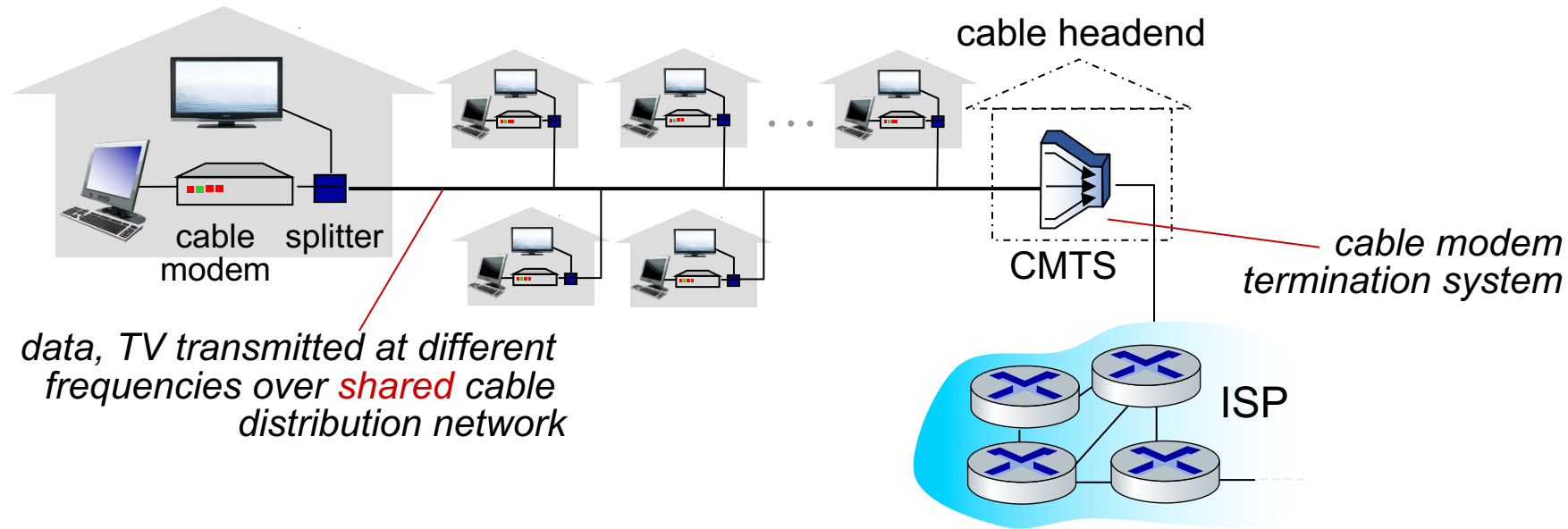

■ HFC: hybrid fiber coax

- asymmetric: up to 40 Mbps – 1.2 Gbps downstream transmission rate, 30-100 Mbps upstream transmission rate
- **network** of cable, fiber attaches homes to ISP router
 - homes *share access network* to cable headend

Access networks: digital subscriber line (DSL)

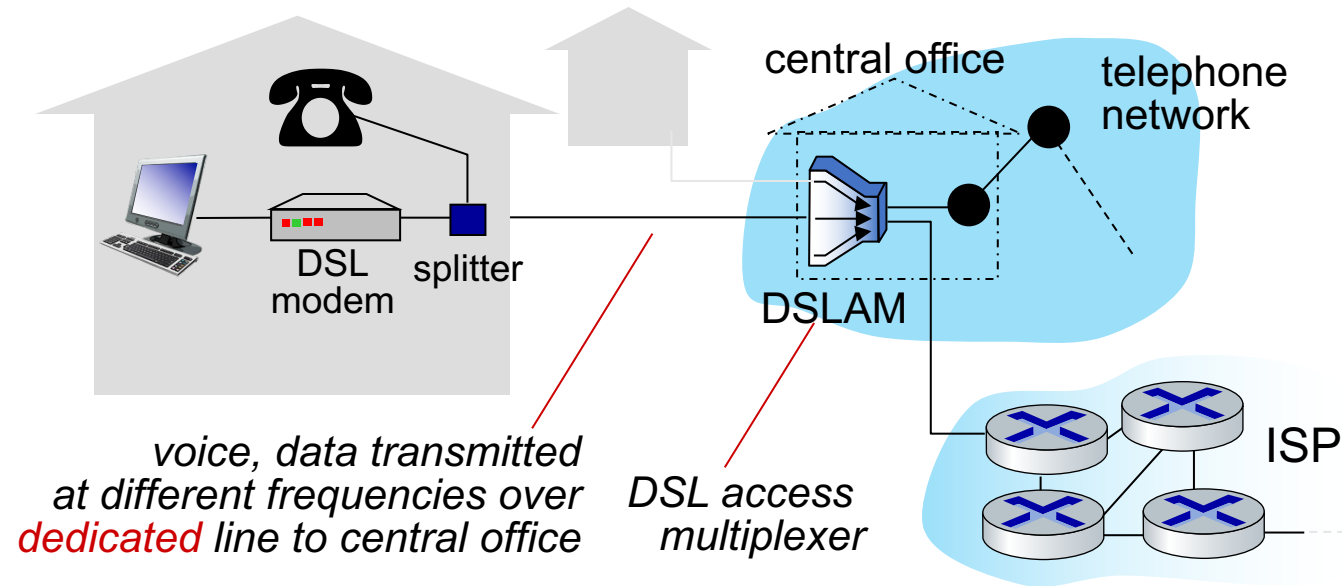

- use *existing* telephone line to central office DSLAM
 - data over DSL phone line goes to Internet
 - voice over DSL phone line goes to telephone net
- 24-52 Mbps dedicated downstream transmission rate
- 3.5-16 Mbps dedicated upstream transmission rate

Access networks: home networks

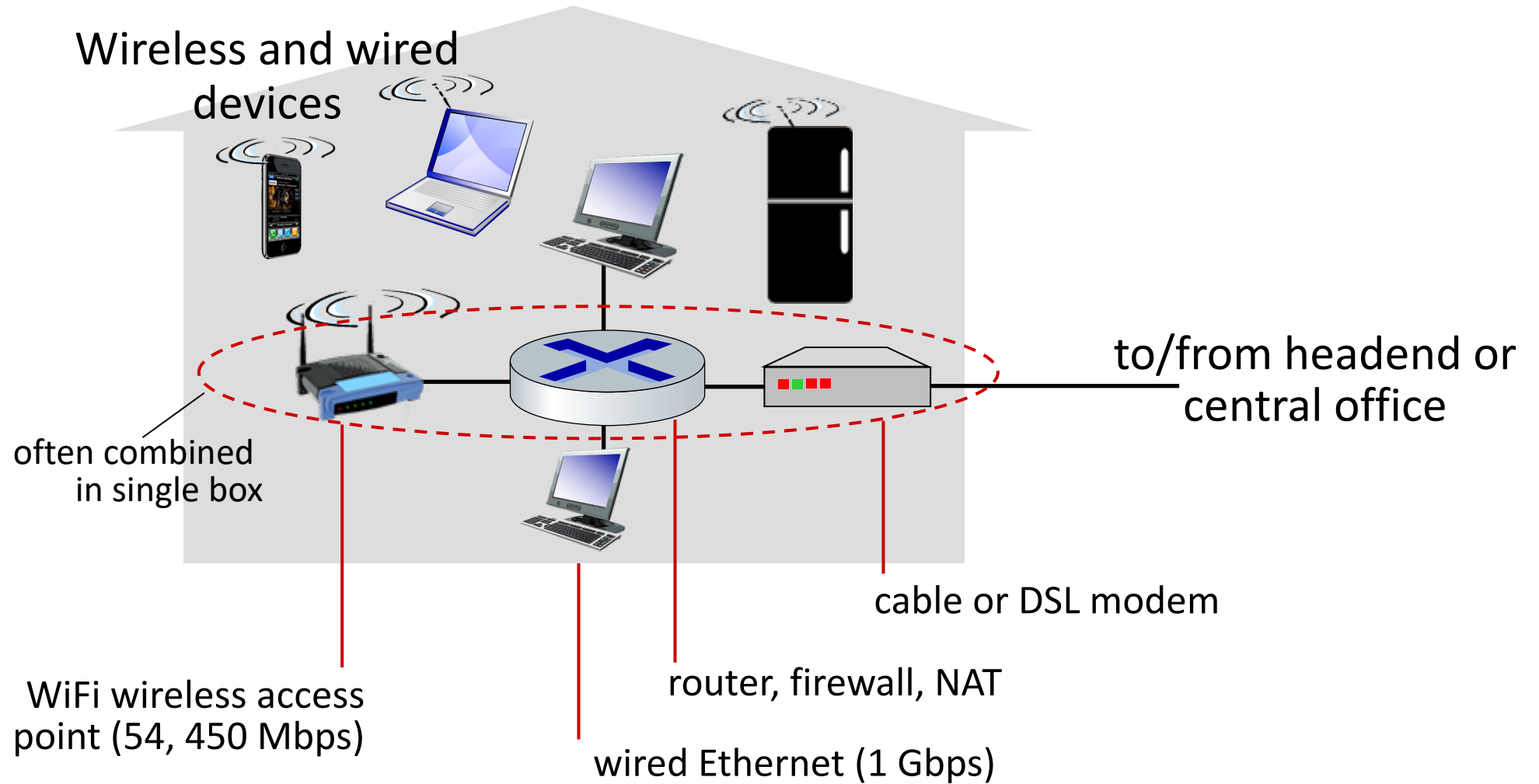

Wireless access networks

Shared *wireless* access network connects end system to router

- via base station aka “access point”

Wireless local area networks (WLANs)

- typically within or around building (~100 ft)
- 802.11b/g/n (WiFi): 11, 54, 450 Mbps transmission rate

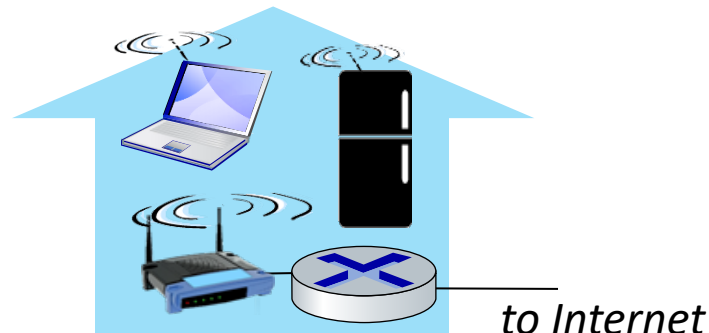

Wide-area cellular access networks

- provided by mobile, cellular network operator (10's km)
- 10's Mbps
- 4G cellular networks (5G coming)

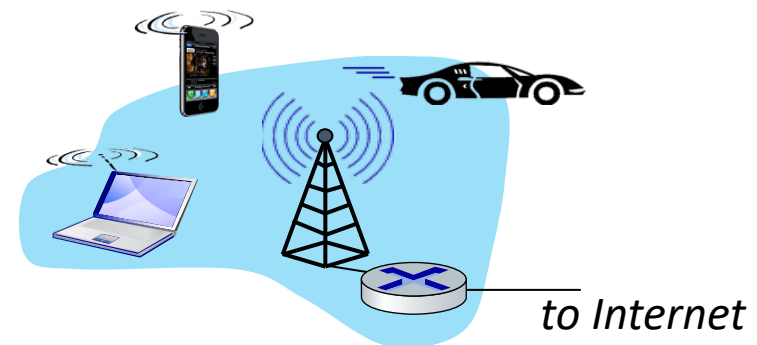

Access networks: enterprise networks

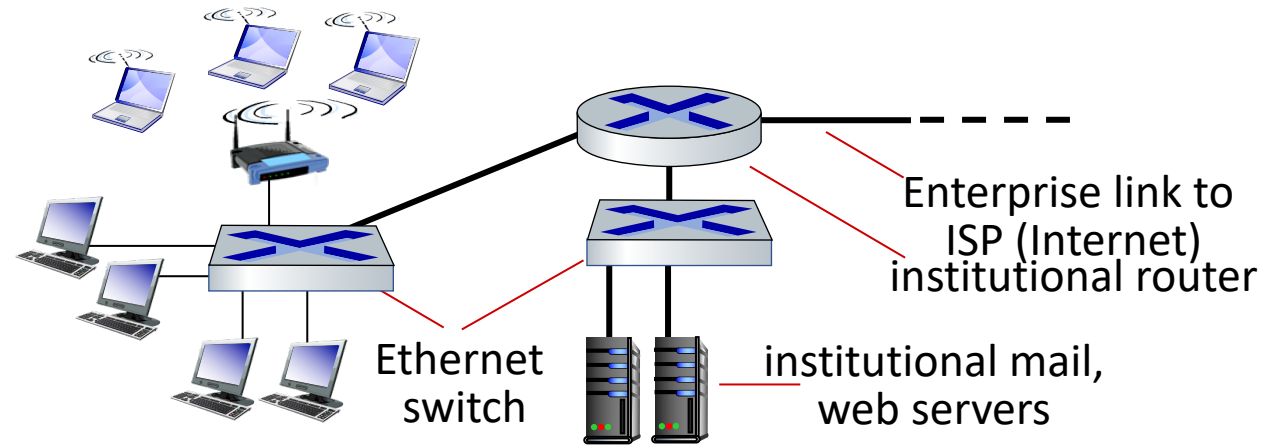

- companies, universities, etc.
- mix of wired, wireless link technologies, connecting a mix of switches and routers (we'll cover differences shortly)
 - Ethernet: wired access at 100Mbps, 1Gbps, 10Gbps
 - WiFi: wireless access points at 11, 54, 450 Mbps

Access networks: data center networks

- high-bandwidth links (10s to 100s Gbps) connect hundreds to thousands of servers together, and to Internet



Courtesy: Massachusetts Green High Performance Computing Center (mghpcc.org)

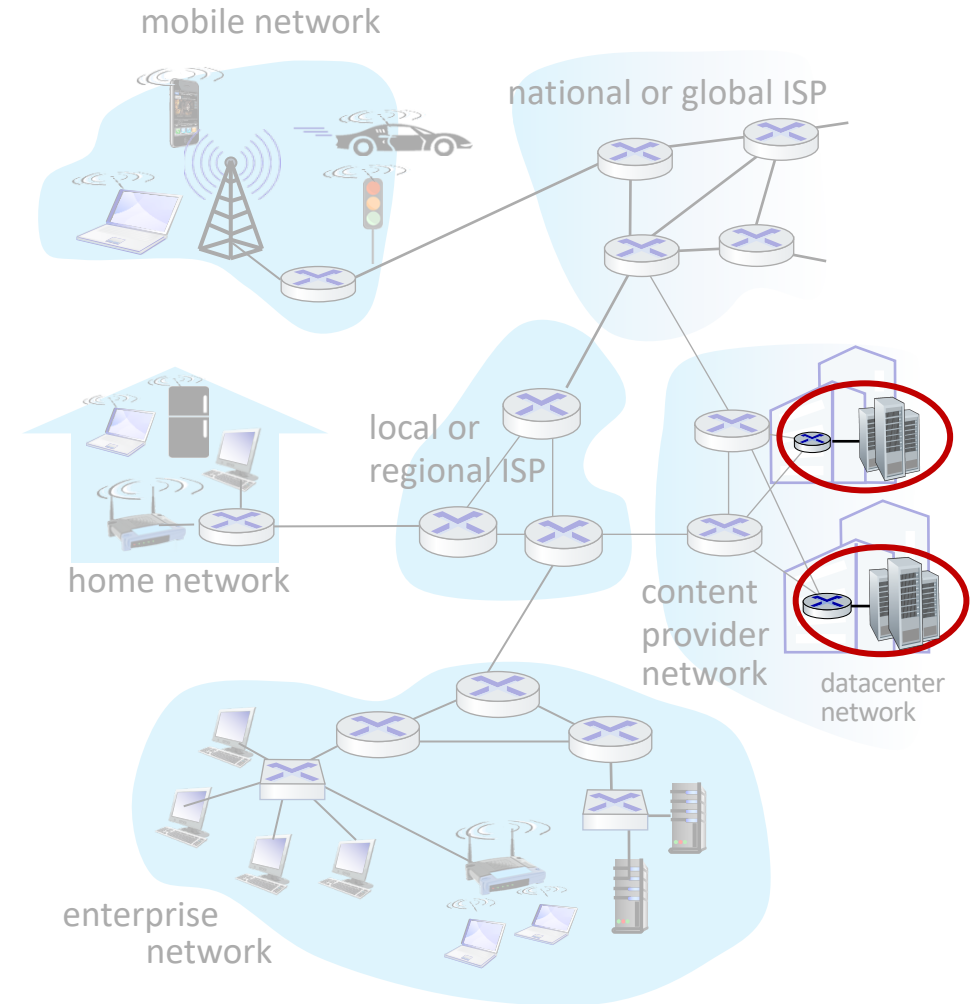

Host: sends *packets* of data

host sending function:

- takes application message
- breaks into smaller chunks, known as *packets*, of length L bits
- transmits packet into access network at *transmission rate* R
 - link transmission rate, aka link *capacity, aka link bandwidth*

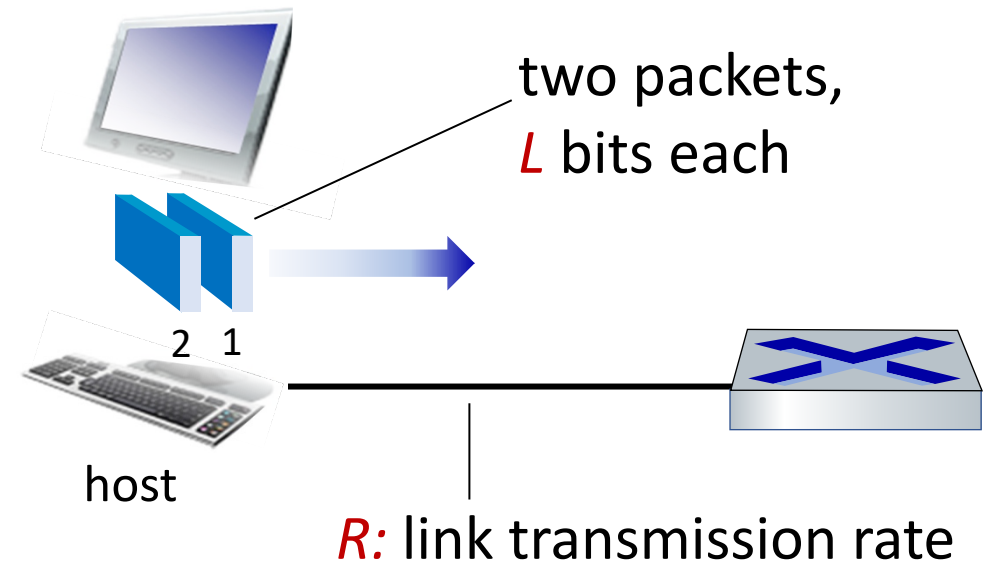

$$\text{packet transmission delay} = \text{time needed to transmit } L\text{-bit packet into link} = \frac{L \text{ (bits)}}{R \text{ (bits/sec)}}$$

Links: physical media

- **bit**: propagates between transmitter/receiver pairs
- **physical link**: what lies between transmitter & receiver
- **guided media**:
 - signals propagate in solid media: copper, fiber, coax
- **unguided media**:
 - signals propagate freely, e.g., radio

Twisted pair (TP)

- two insulated copper wires
 - Category 5: 100 Mbps, 1 Gbps Ethernet
 - Category 6: 10Gbps Ethernet

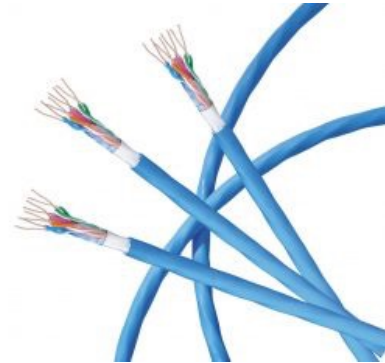

Links: physical media

Coaxial cable:

- two concentric copper conductors
- bidirectional
- broadband:
 - multiple frequency channels on cable
 - 100's Mbps per channel



Fiber optic cable:

- glass fiber carrying light pulses, each pulse a bit
- high-speed operation:
 - high-speed point-to-point transmission (10's-100's Gbps)
- low error rate:
 - repeaters spaced far apart
 - immune to electromagnetic noise

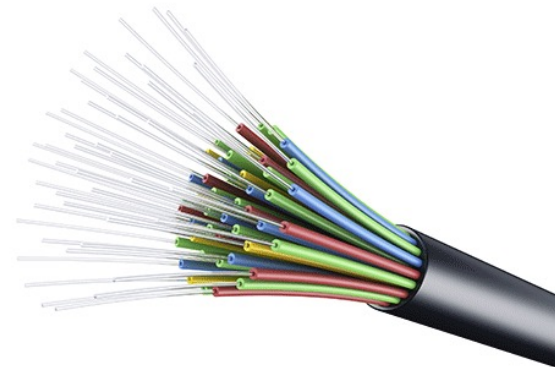

Links: physical media

Wireless radio

- signal carried in various “bands” in electromagnetic spectrum
- no physical “wire”
- broadcast, “half-duplex” (sender to receiver)
- propagation environment effects:
 - reflection
 - obstruction by objects
 - Interference/noise

Radio link types:

- **Wireless LAN (WiFi)**
 - 10-100’s Mbps; 10’s of meters
- **wide-area (e.g., 4G cellular)**
 - 10’s Mbps over ~10 Km
- **Bluetooth: cable replacement**
 - short distances, limited rates
- **terrestrial microwave**
 - point-to-point; 45 Mbps channels
- **satellite**
 - up to 45 Mbps per channel
 - 270 msec end-end delay

Chapter 1: roadmap

- What *is* the Internet?
- What *is* a protocol?
- Network edge: hosts, access network, physical media
- **Network core:** packet/circuit switching, internet structure
- Performance: loss, delay, throughput
- Security
- Protocol layers, service models
- History



The network core

- mesh of interconnected routers
- **packet-switching**: hosts break application-layer messages into *packets*
 - network **forwards** packets from one router to the next, across links on path from **source to destination**

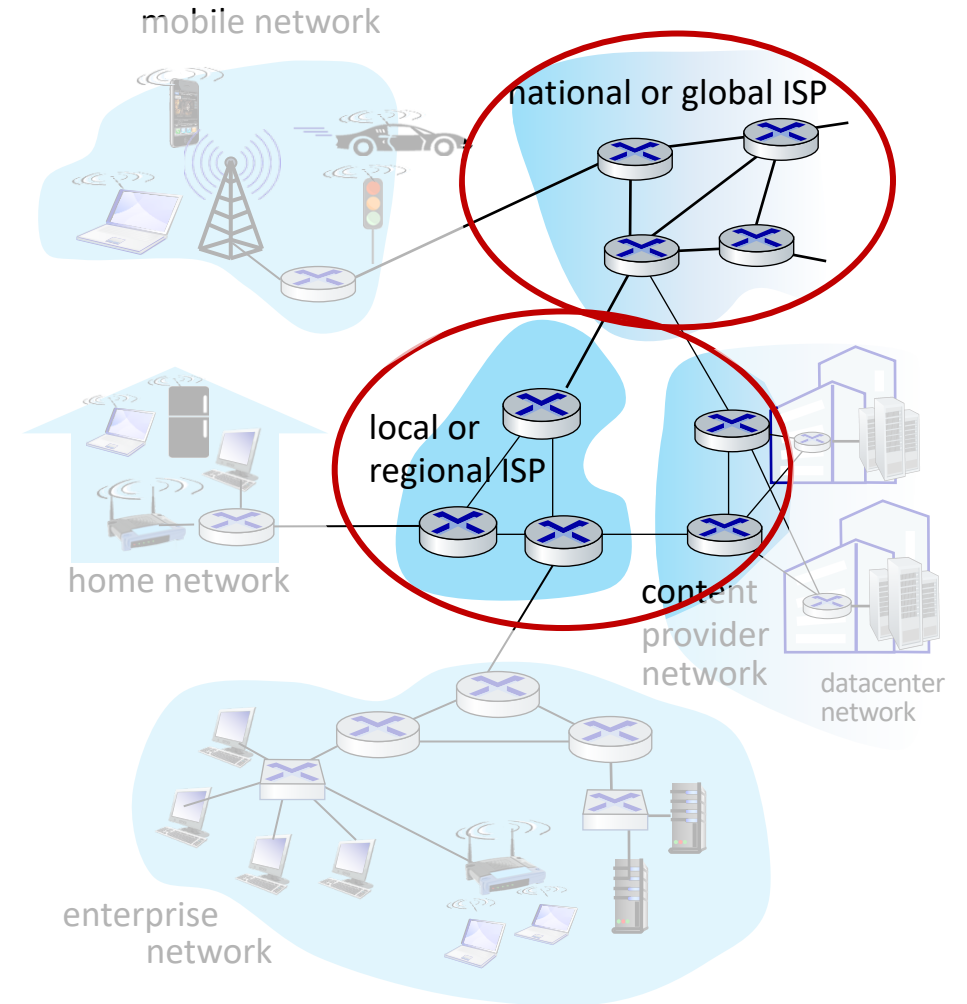

Two key network-core functions

Forwarding:

- aka “switching”
- *local* action: move arriving packets from router’s input link to appropriate router output link

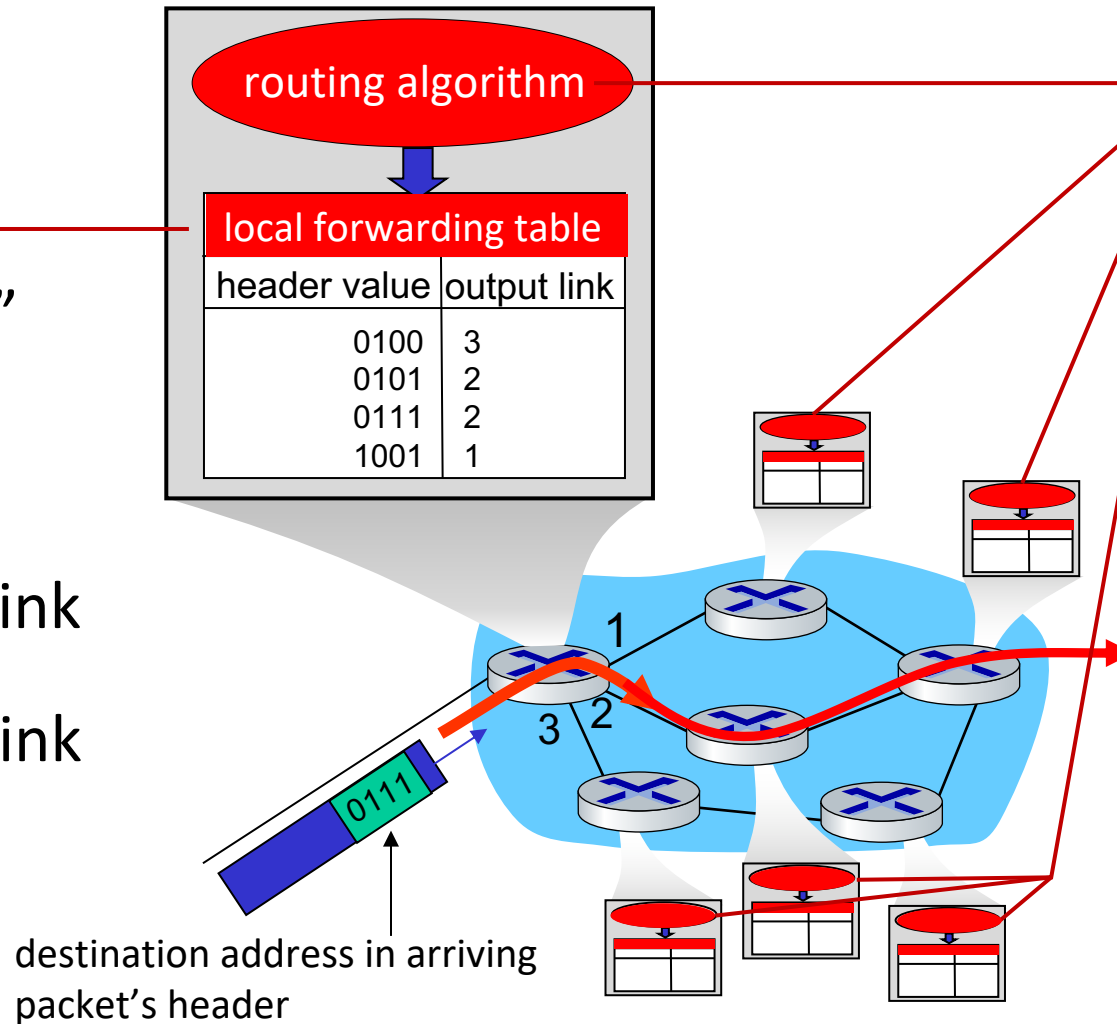

Routing:

- *global* action: determine source-destination paths taken by packets
- routing algorithms





Packet-switching: store-and-forward

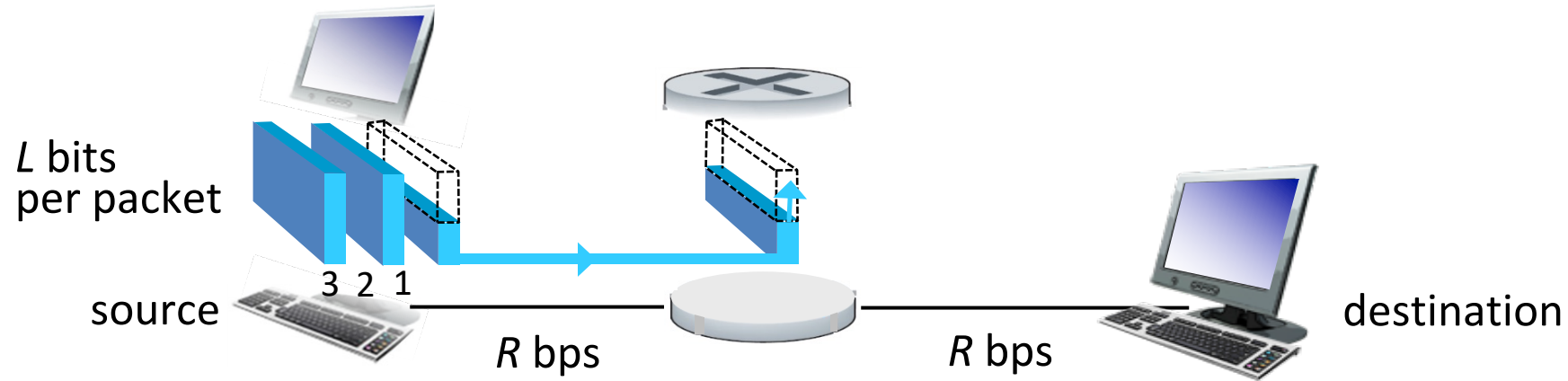

- **packet transmission delay:** takes L/R seconds to transmit (push out) L -bit packet into link at R bps
- **store and forward:** entire packet must arrive at router before it can be transmitted on next link

One-hop numerical example:

- $L = 10$ Kbits
- $R = 100$ Mbps
- one-hop transmission delay = 0.1 msec

Packet-switching: queueing

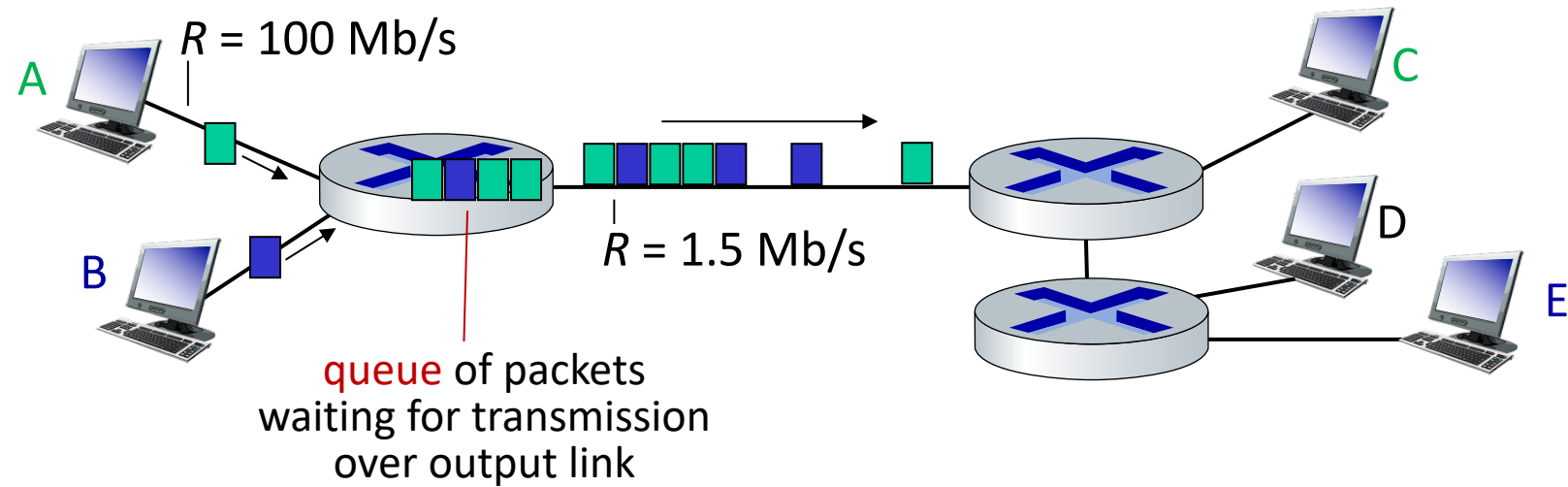

Queueing occurs when work arrives faster than it can be serviced:



Packet-switching: queueing

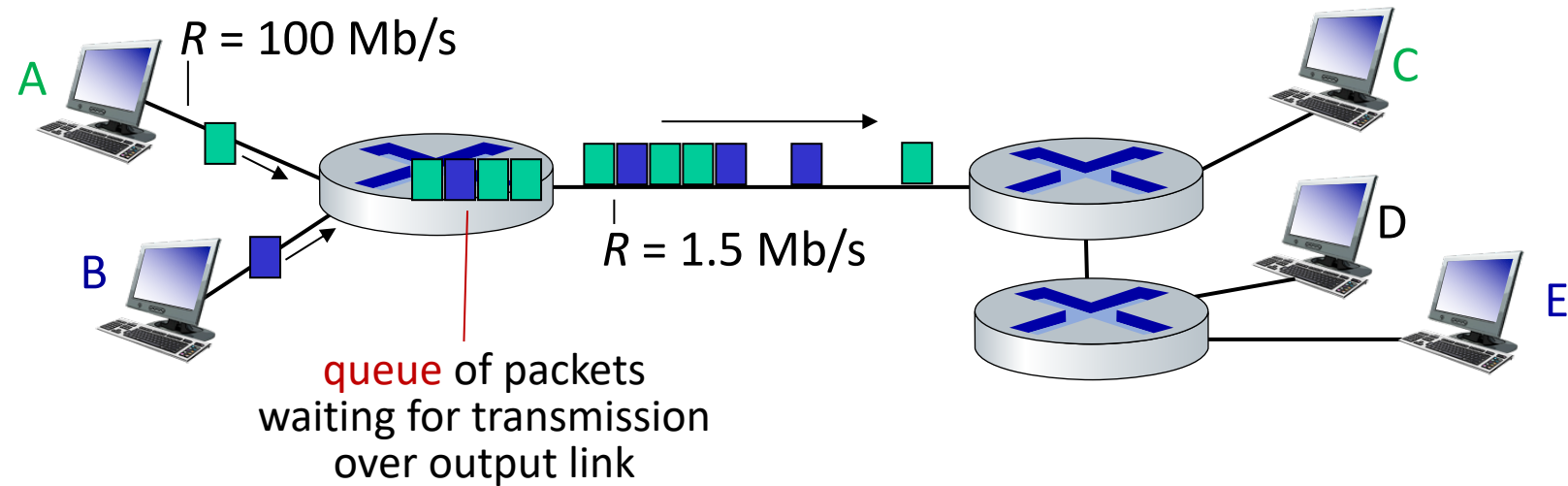

Packet queuing and loss: if arrival rate (in bps) to link exceeds transmission rate (bps) of link for some period of time:

- packets will queue, waiting to be transmitted on output link
- packets can be dropped (lost) if memory (buffer) in router fills up

Alternative to packet switching: circuit switching

end-end resources allocated to, reserved for “call” between source and destination

- in diagram, each link has four circuits.
 - call gets 2nd circuit in top link and 1st circuit in right link.
- dedicated resources: no sharing
 - circuit-like (guaranteed) performance
- circuit segment idle if not used by call (no sharing)
- commonly used in traditional telephone networks

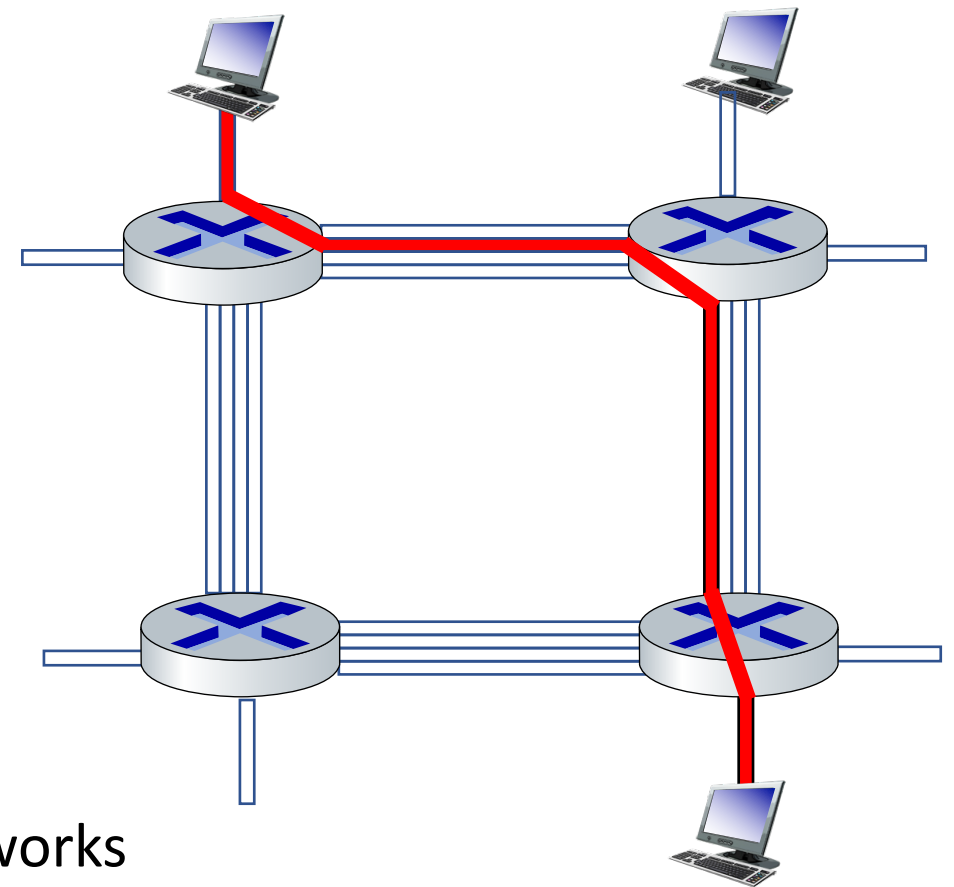

* Check out the online interactive exercises for more examples: http://gaia.cs.umass.edu/kurose_ross/interactive

Circuit switching: FDM and TDM

Frequency Division Multiplexing (FDM)

- optical, electromagnetic frequencies divided into (narrow) frequency bands
- each call allocated its own band, can transmit at max rate of that narrow band

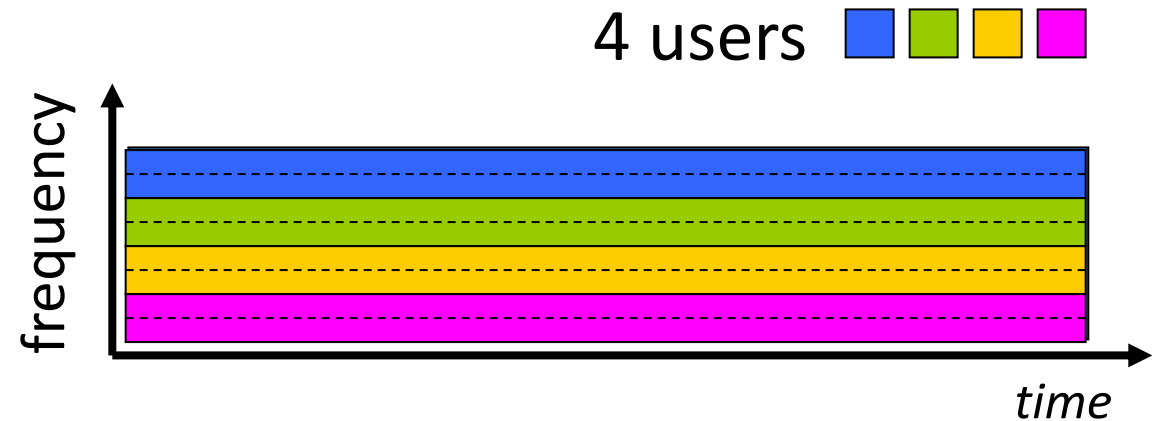

Time Division Multiplexing (TDM)

- time divided into slots
- each call allocated periodic slot(s), can transmit at maximum rate of (wider) frequency band (only) during its time slot(s)

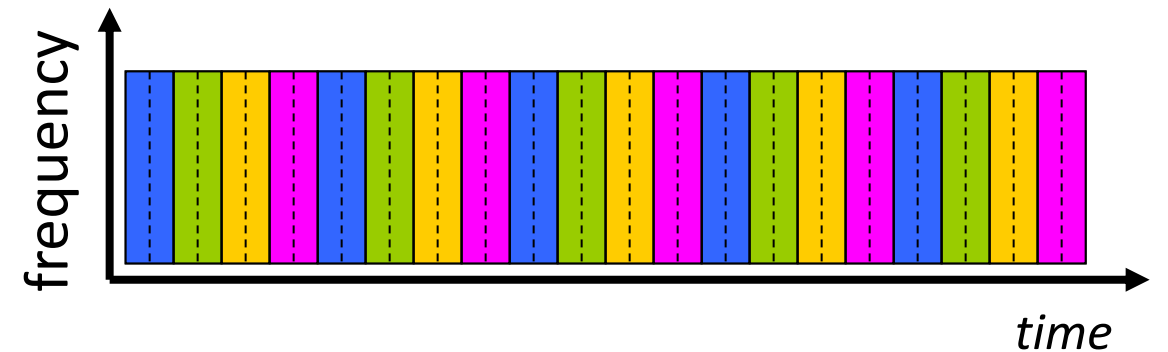

Packet switching versus circuit switching

example:

- 1 Gb/s link
- each user:
 - 100 Mb/s when “active”
 - active 10% of time

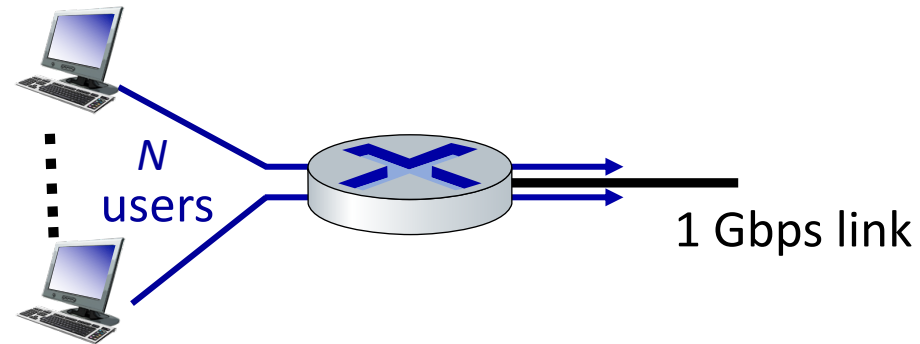

Q: how many users can use this network under circuit-switching and packet switching?

- **circuit-switching:** 10 users
- **packet switching:** with 35 users, probability > 10 active at same time is less than .0004 *

Q: how did we get value 0.0004?

A: HW problem (for those with course in probability only)

* Check out the online interactive exercises for more examples: http://gaia.cs.umass.edu/kurose_ross/interactive

Packet switching versus circuit switching

Is packet switching a “slam dunk winner”?

- great for “bursty” data – sometimes has data to send, but at other times not
 - resource sharing
 - simpler, no call setup
- **excessive congestion possible:** packet delay and loss due to buffer overflow
 - protocols needed for reliable data transfer, congestion control
- **Q: How to provide circuit-like behavior with packet-switching?**
 - “It’s complicated.” We’ll study various techniques that try to make packet switching as “circuit-like” as possible.

Q: human analogies of reserved resources (circuit switching) versus on-demand allocation (packet switching)?

Internet structure: a “network of networks”

- hosts connect to Internet via **access** Internet Service Providers (ISPs)
- access ISPs in turn must be interconnected
 - so that *any* two hosts (*anywhere!*) can send packets to each other
- resulting network of networks is very complex
 - evolution driven by **economics**, **national policies**

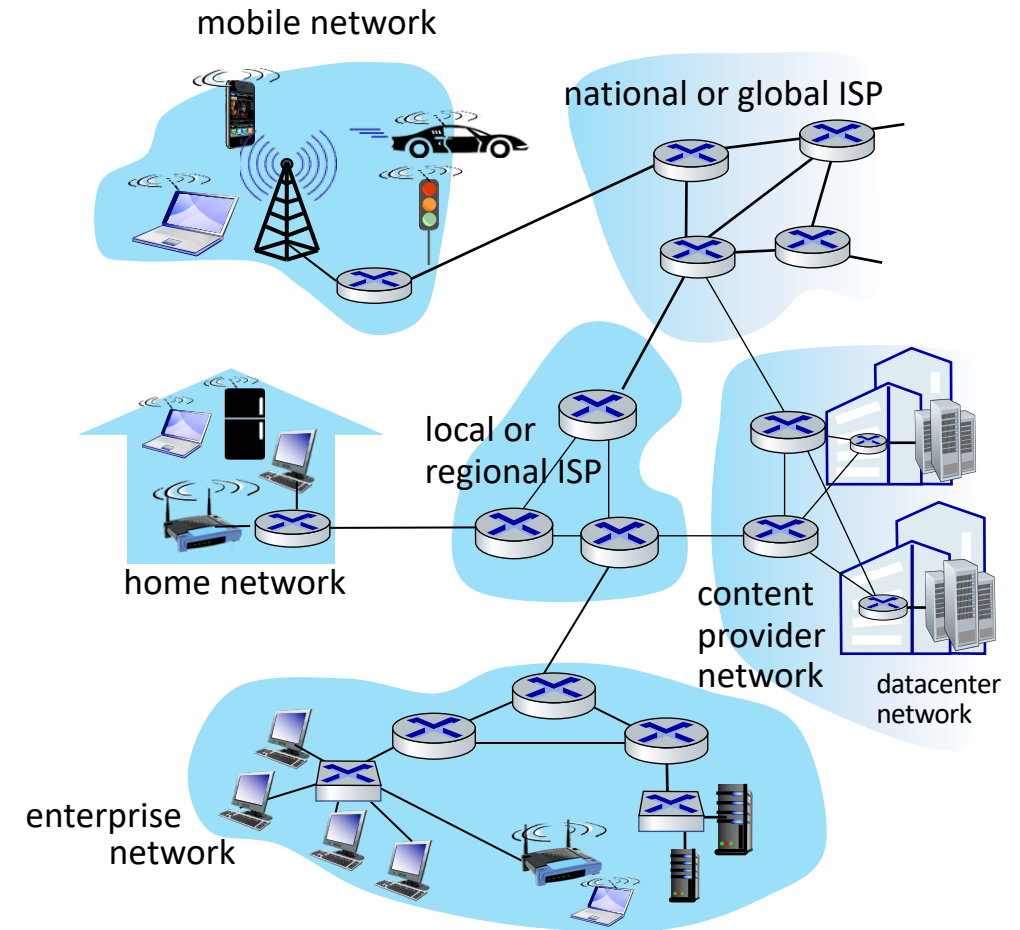

Let's take a stepwise approach to describe current Internet structure

Internet structure: a “network of networks”

Question: given *millions* of access ISPs, how to connect them together?

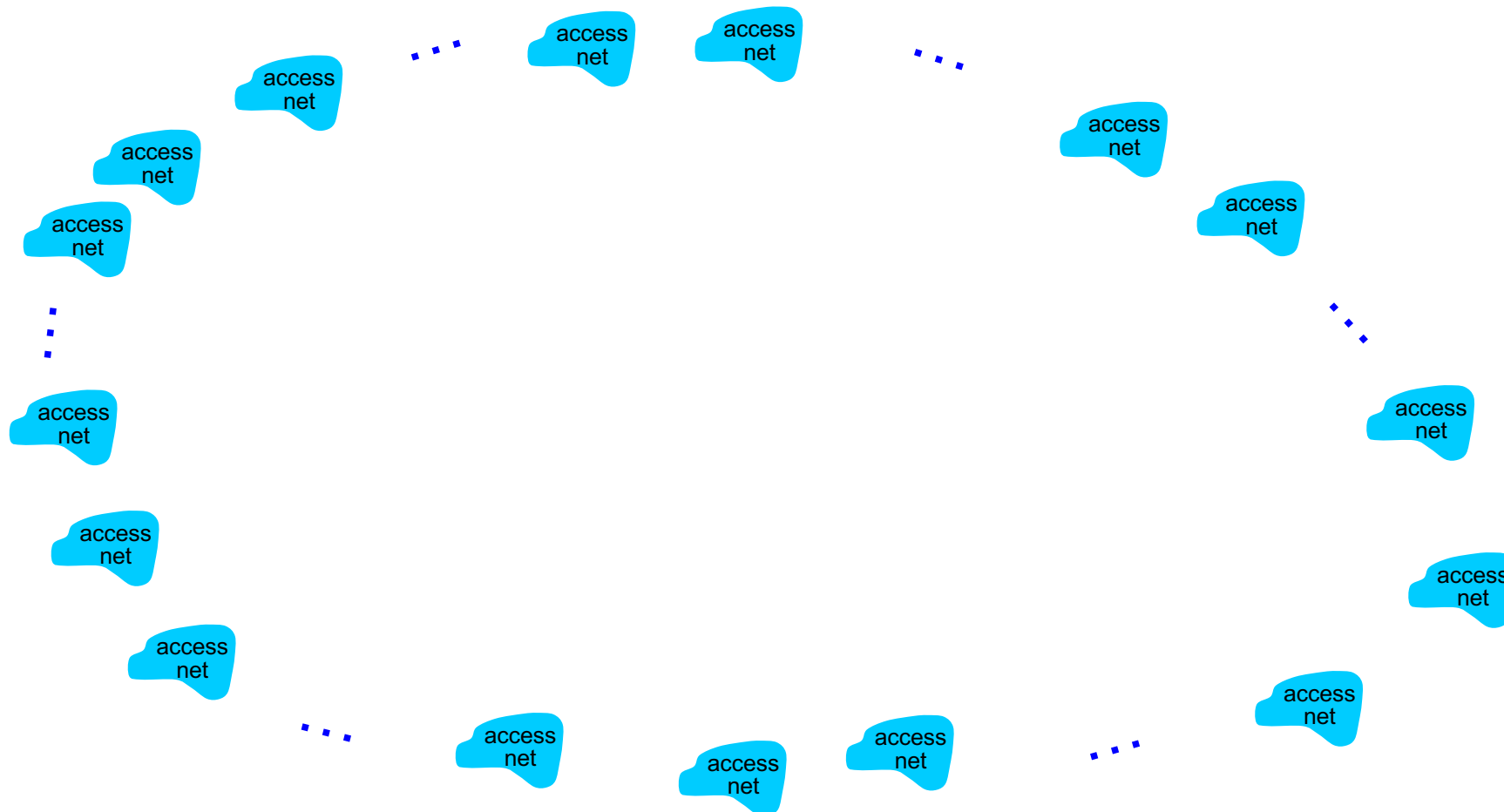

Internet structure: a “network of networks”

Question: given *millions* of access ISPs, how to connect them together?

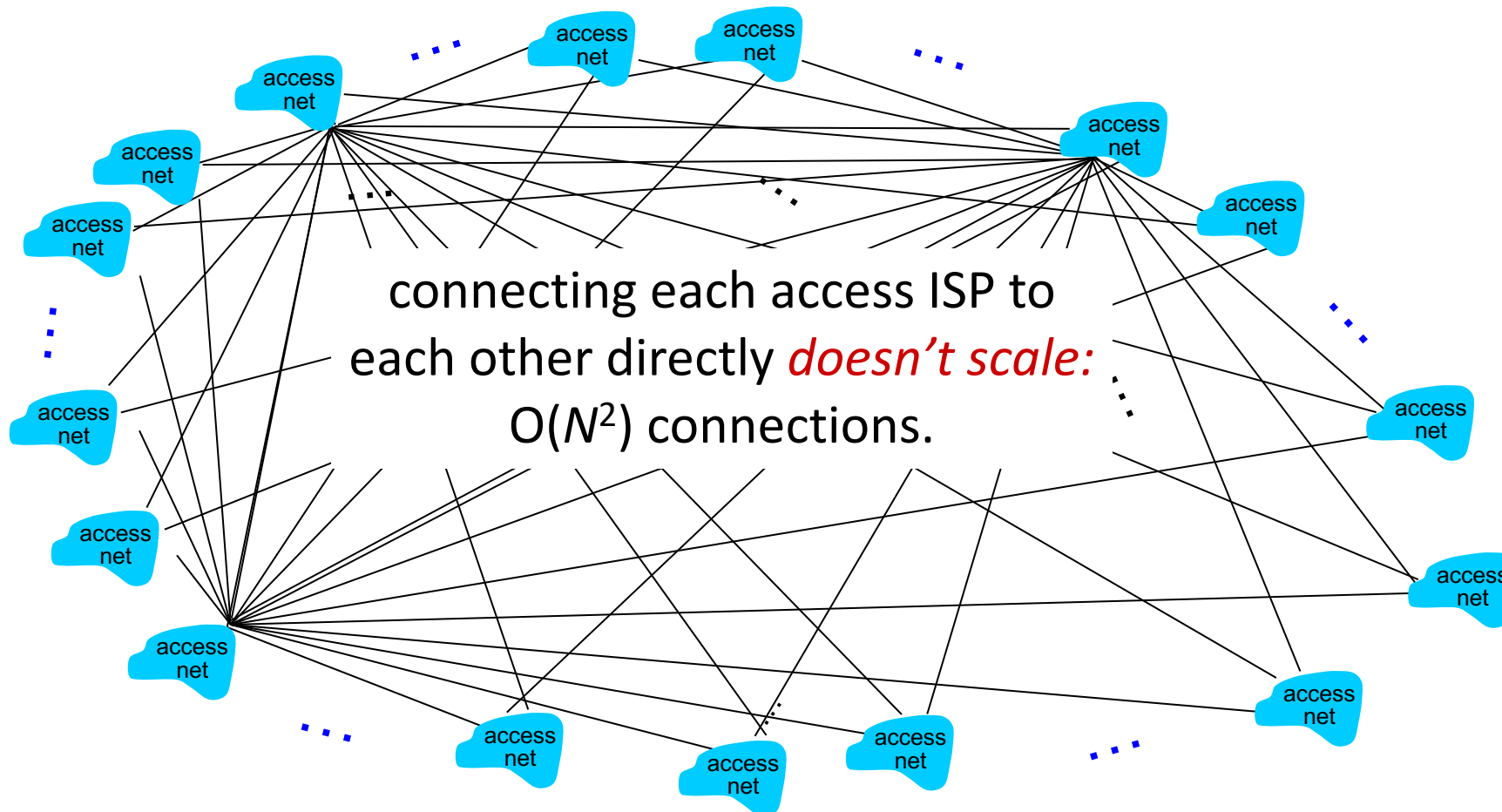

Internet structure: a “network of networks”

Option: connect each access ISP to one global transit ISP?

Customer and provider ISPs have economic agreement.

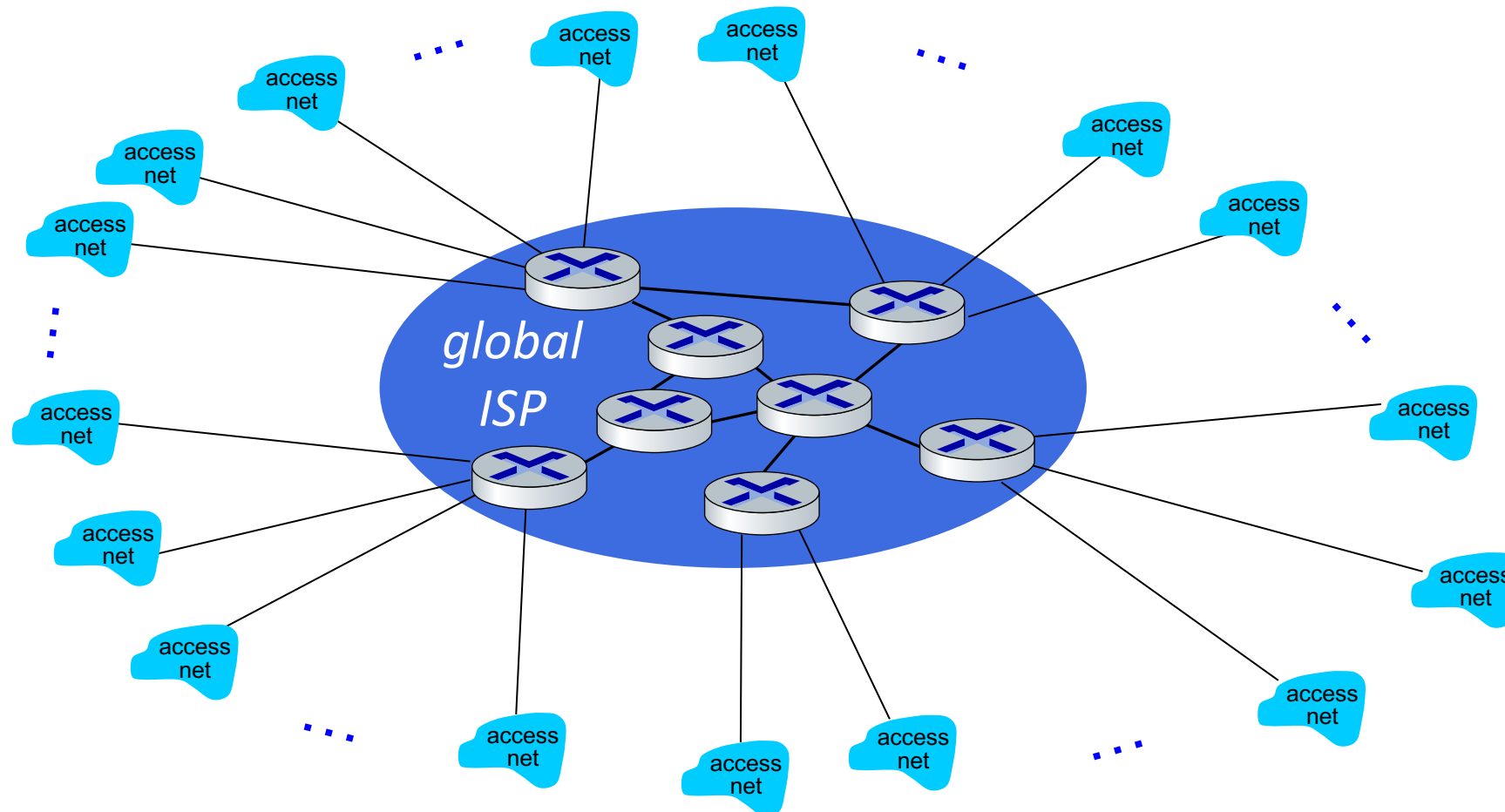

Internet structure: a “network of networks”

But if one global ISP is viable business, there will be competitors

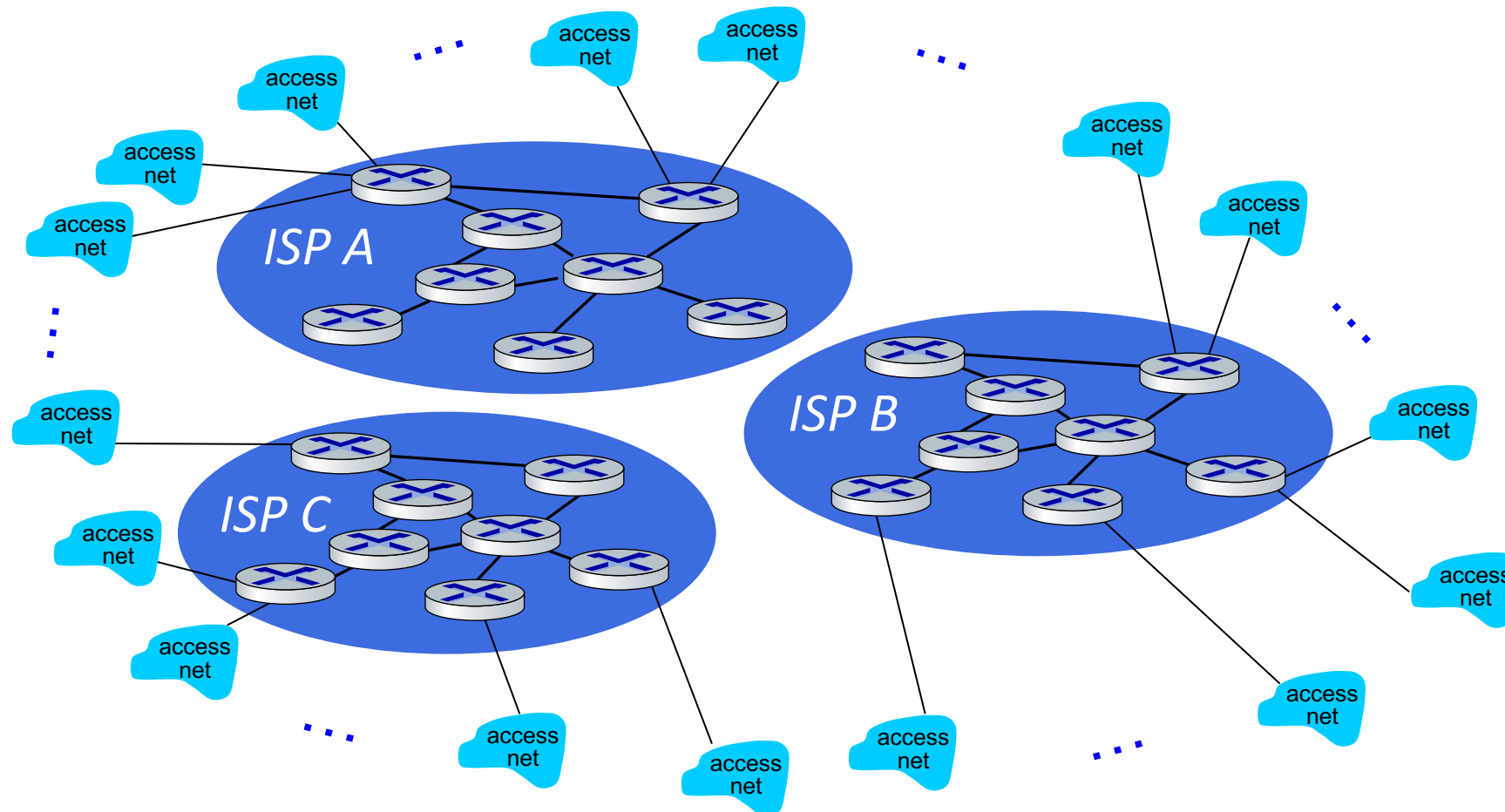

Internet structure: a “network of networks”

But if one global ISP is viable business, there will be competitors who will want to be connected

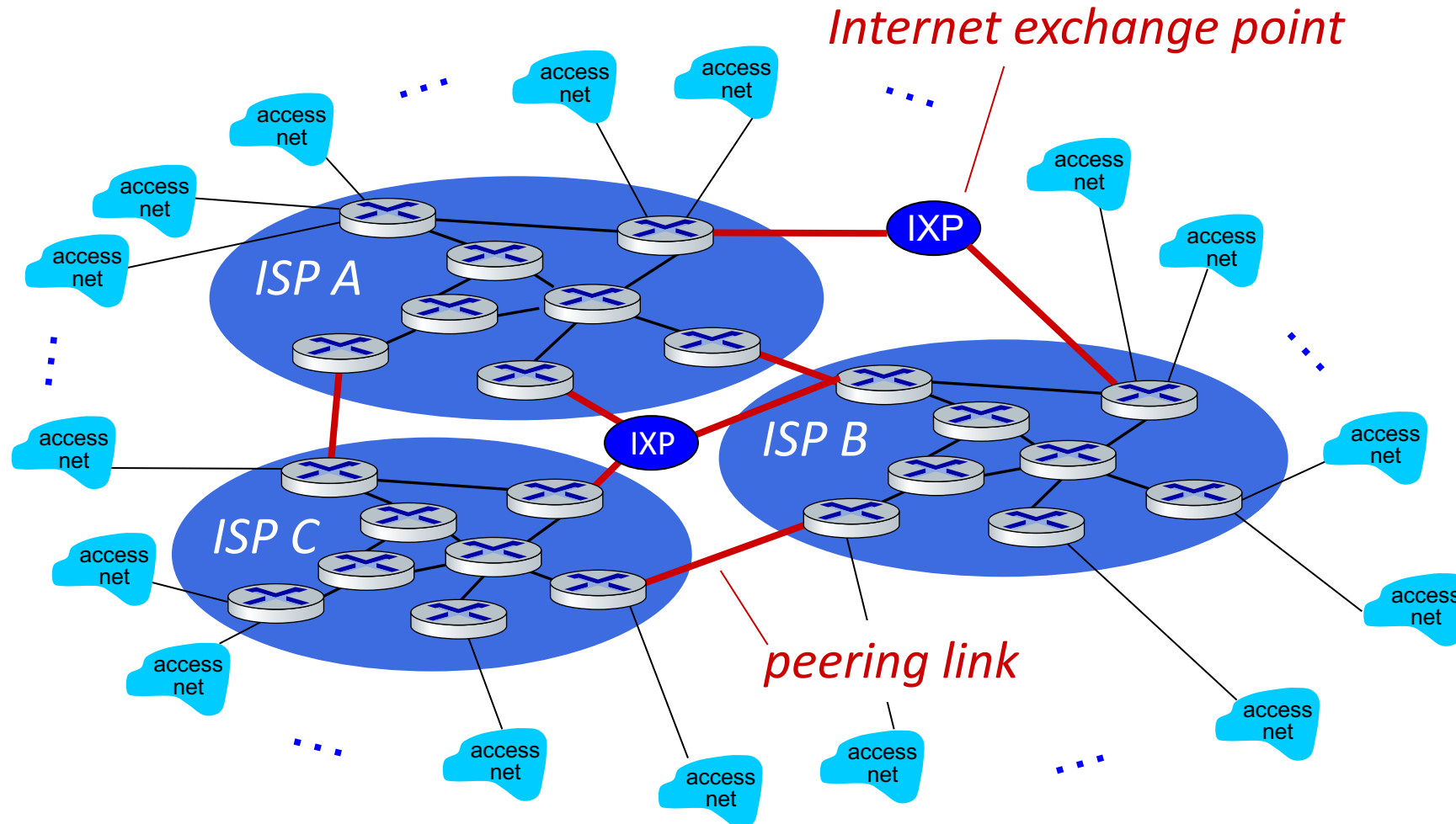

Internet structure: a “network of networks”

... and regional networks may arise to connect access nets to ISPs

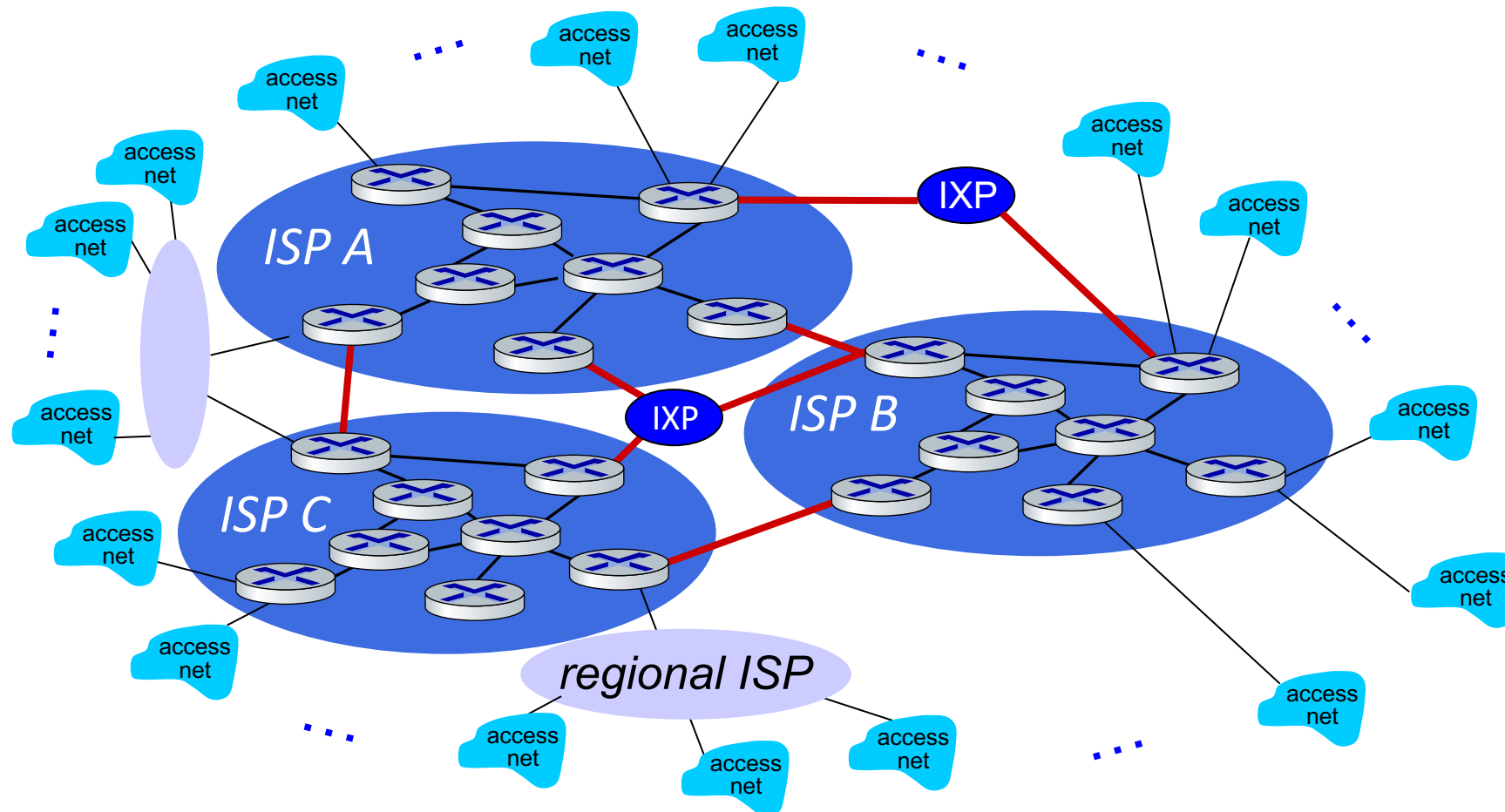

Internet structure: a “network of networks”

... and content provider networks (e.g., Google, Microsoft, Akamai) may run their own network, to bring services, content close to end users

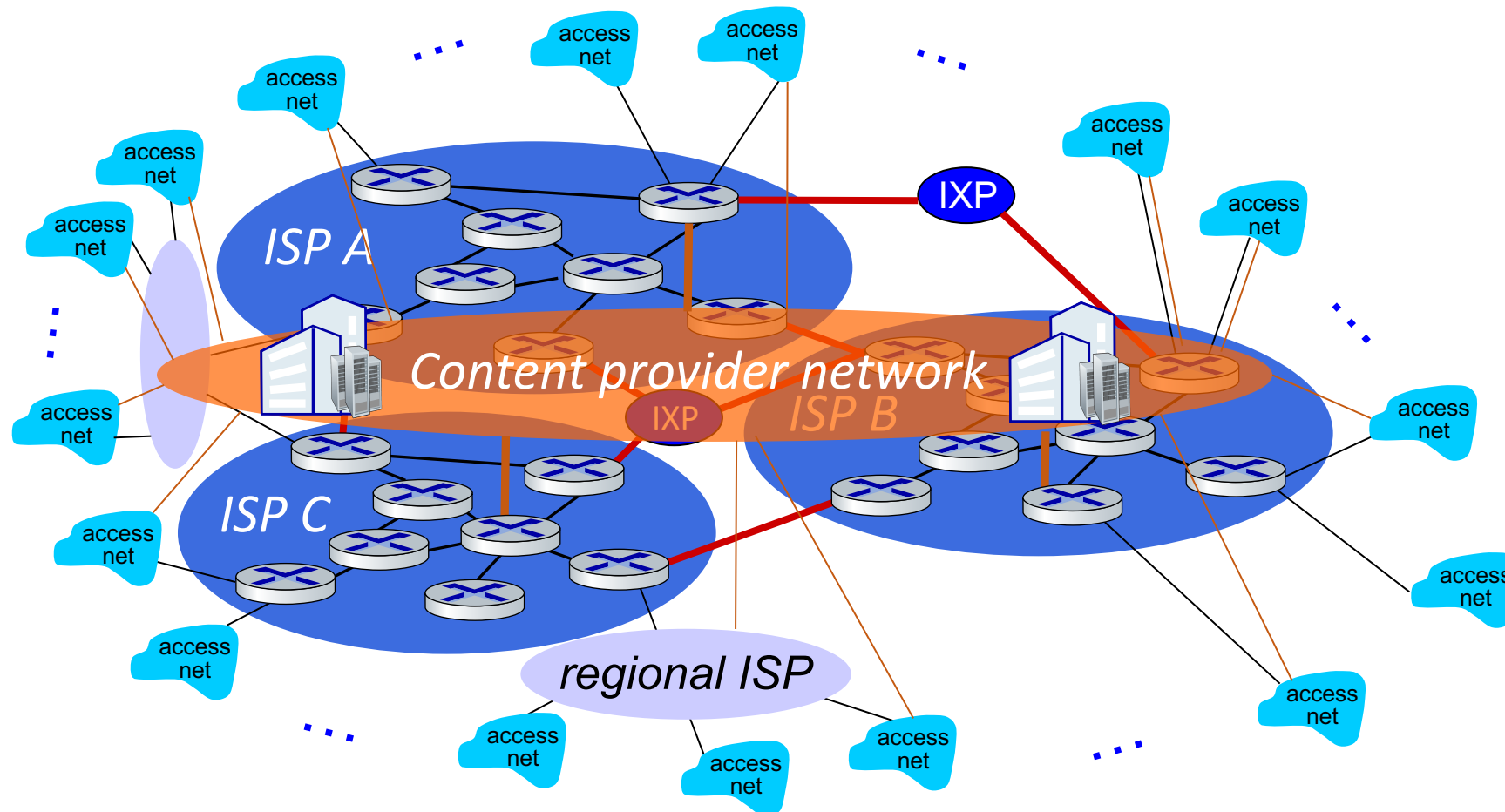

Internet structure: a “network of networks”

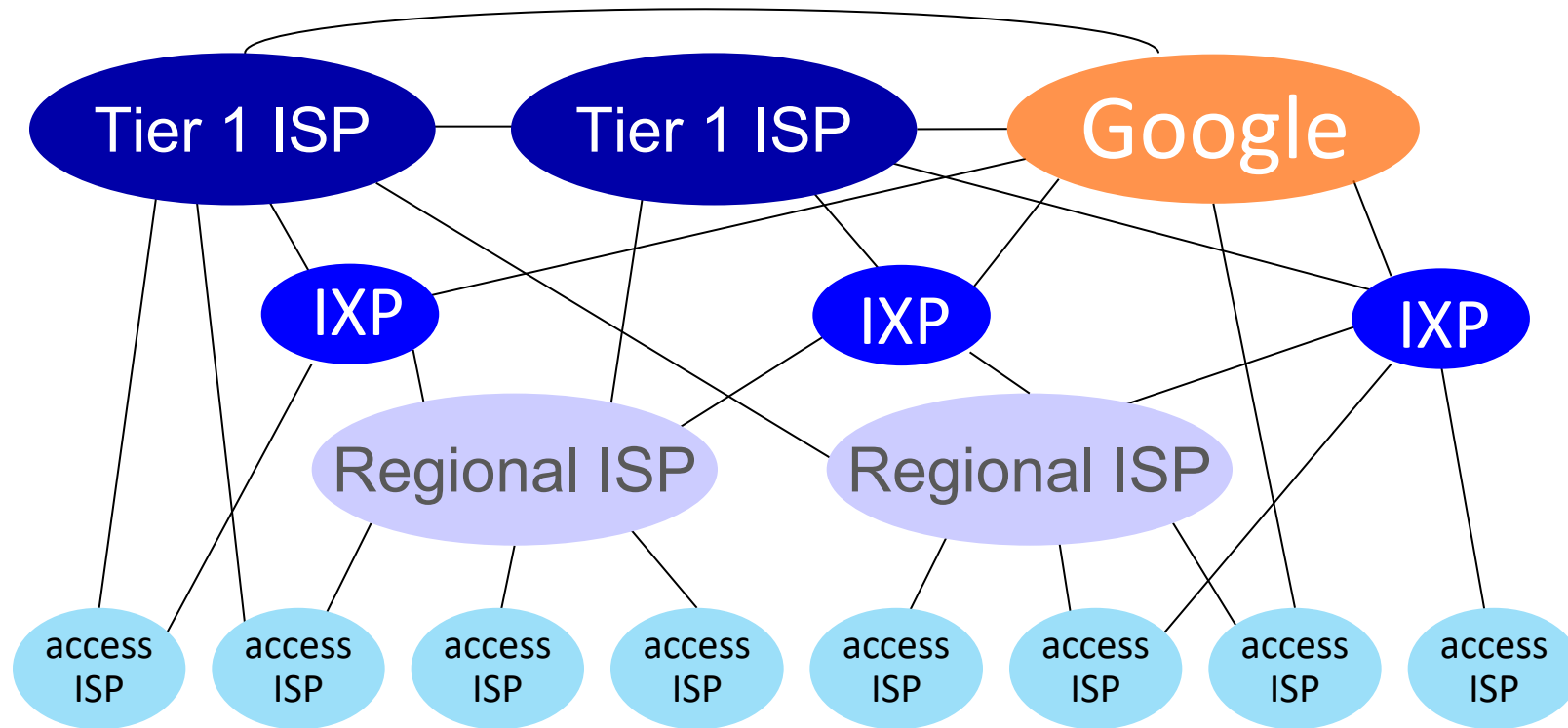

At “center”: small # of well-connected large networks

- **“tier-1” commercial ISPs** (e.g., Level 3, Sprint, AT&T, NTT), national & international coverage
- **content provider networks** (e.g., Google, Facebook): private network that connects its data centers to Internet, often bypassing tier-1, regional ISPs

Chapter 1: roadmap

- What *is* the Internet?
- What *is* a protocol?
- Network edge: hosts, access network, physical media
- Network core: packet/circuit switching, internet structure
- **Performance: loss, delay, throughput**
- Security
- Protocol layers, service models
- History



How do packet delay and loss occur?

- packets *queue* in router buffers, waiting for turn for transmission
 - queue length grows when arrival rate to link (temporarily) exceeds output link capacity
- packet *loss* occurs when memory to hold queued packets fills up

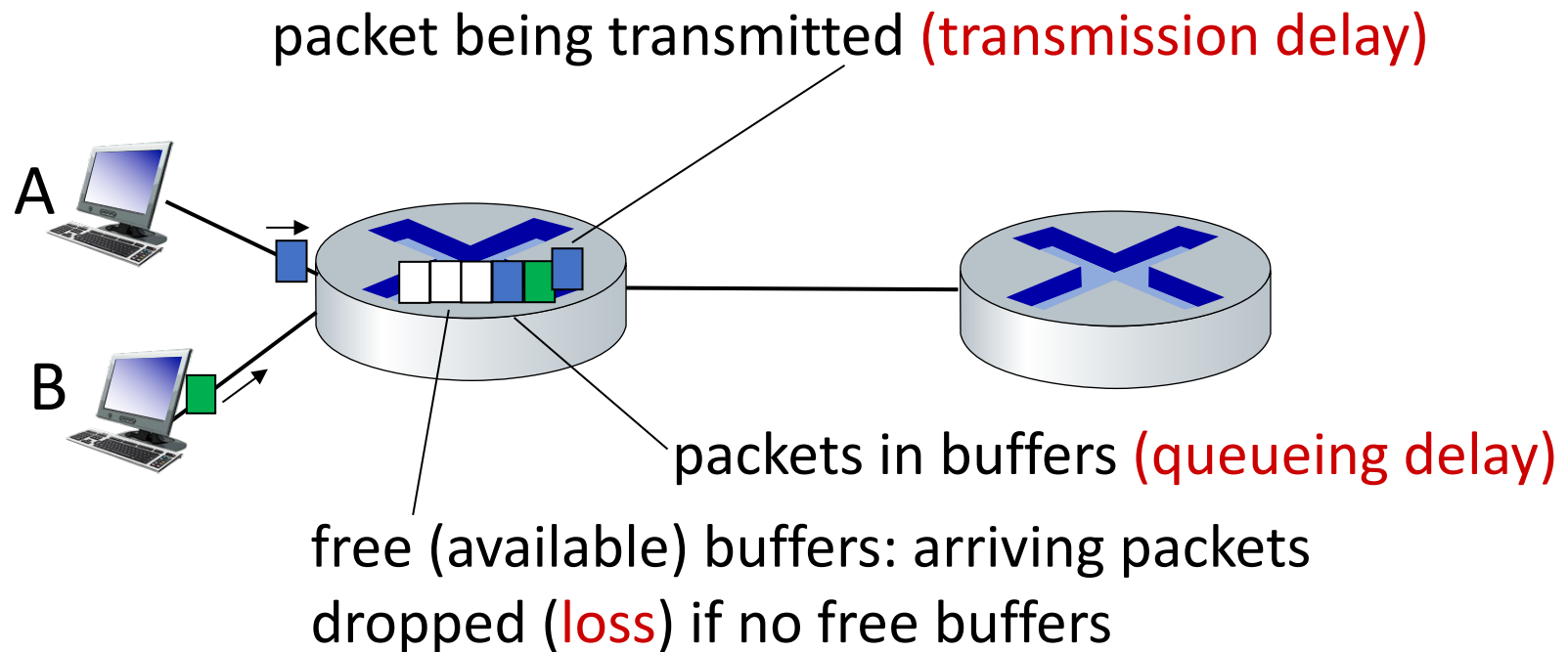

Packet delay: four sources

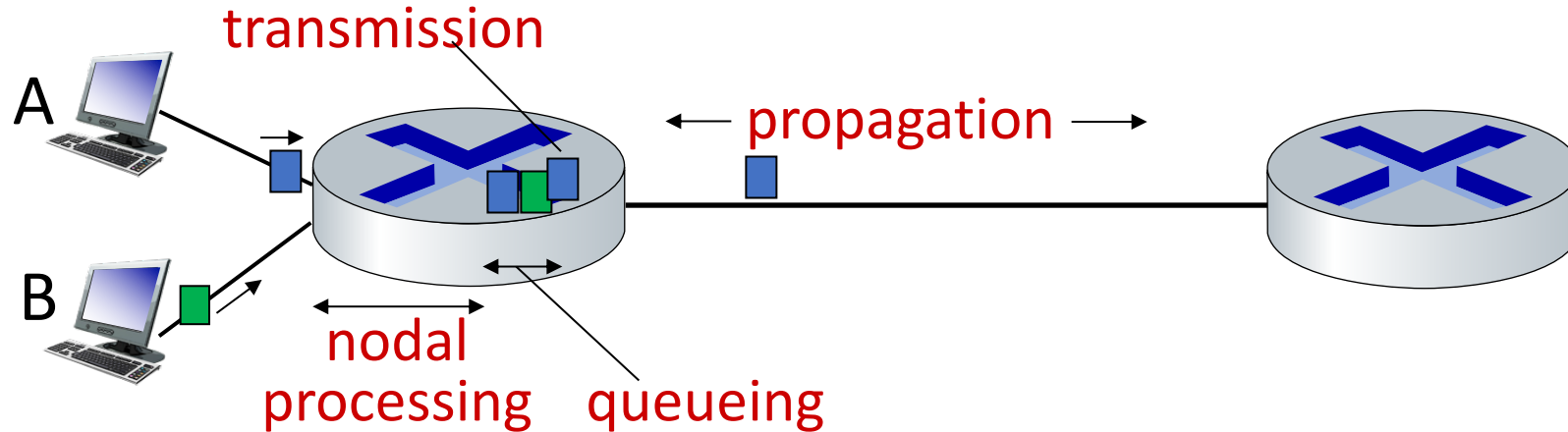

$$d_{\text{nodal}} = d_{\text{proc}} + d_{\text{queue}} + d_{\text{trans}} + d_{\text{prop}}$$

d_{proc} : nodal processing

- check bit errors
- determine output link
- typically < microseconds

d_{queue} : queueing delay

- time waiting at output link for transmission
- depends on congestion level of router

Packet delay: four sources

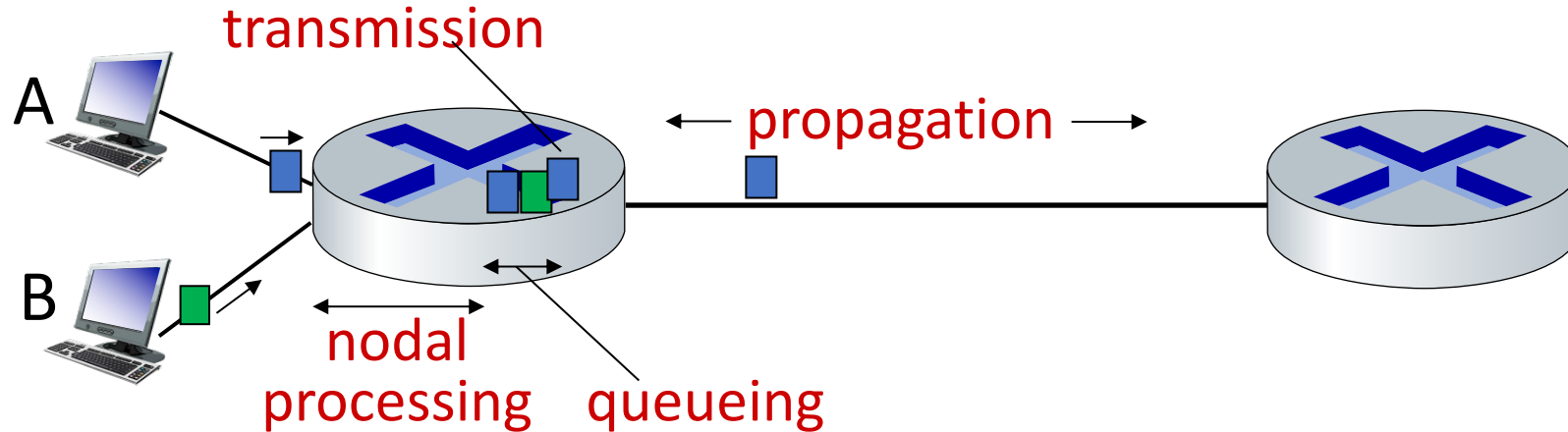

$$d_{\text{nodal}} = d_{\text{proc}} + d_{\text{queue}} + d_{\text{trans}} + d_{\text{prop}}$$

d_{trans} : transmission delay:

- L : packet length (bits)
- R : link transmission rate (bps)

▪ $d_{\text{trans}} = L/R$

d_{prop} : propagation delay:

- d : length of physical link
- s : propagation speed ($\sim 2 \times 10^8$ m/sec)

▪ $d_{\text{prop}} = d/s$

d_{trans} and d_{prop}
very different

Caravan analogy

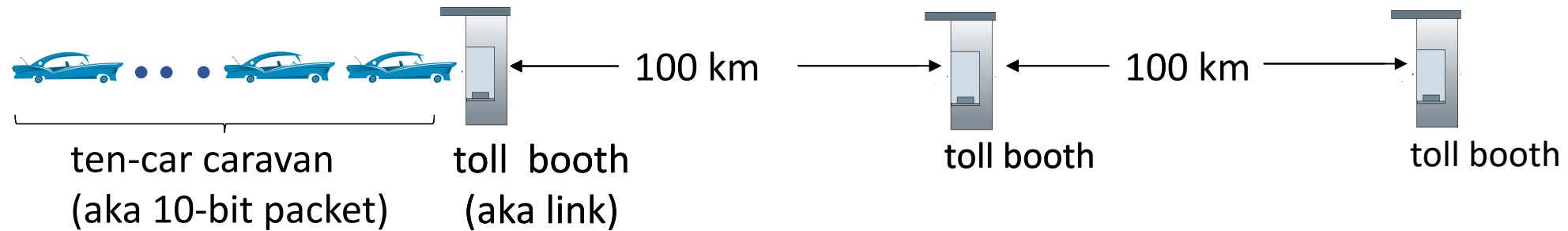

- car \sim bit; caravan \sim packet; toll service \sim link transmission
- toll booth takes 12 sec to service car (bit transmission time)
- “propagate” at 100 km/hr
- **Q: How long until caravan is lined up before 2nd toll booth?**
- time to “push” entire caravan through toll booth onto highway = $12 * 10 = 120$ sec
- time for last car to propagate from 1st to 2nd toll booth: $100\text{km}/(100\text{km/hr}) = 1$ hr
- **A: 62 minutes**

Caravan analogy

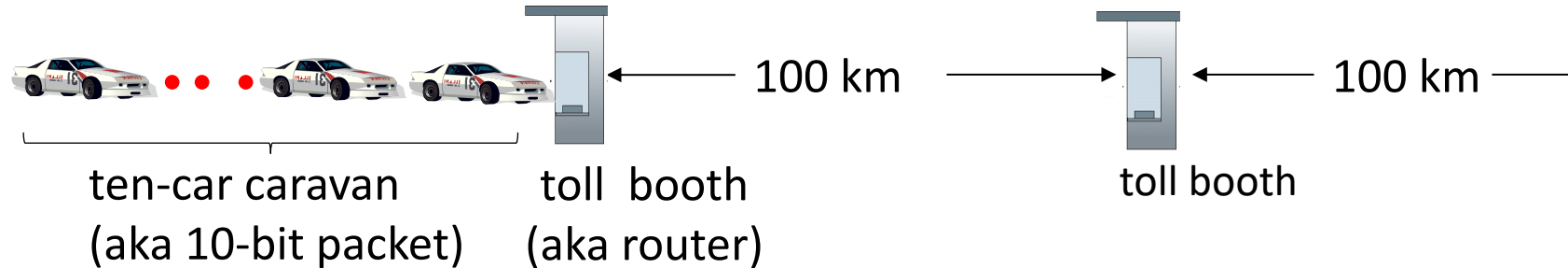

- suppose cars now “propagate” at 1000 km/hr
- and suppose toll booth now takes one min to service a car
- **Q: Will cars arrive to 2nd booth before all cars serviced at first booth?**
A: Yes! after 7 min, first car arrives at second booth; three cars still at first booth

Packet queueing delay (revisited)

- a : average packet arrival rate
- L : packet length (bits)
- R : link bandwidth (bit transmission rate)

$$\frac{L \cdot a}{R} : \frac{\text{arrival rate of bits}}{\text{service rate of bits}} \quad \text{“traffic intensity”}$$

- $La/R \sim 0$: avg. queueing delay small
- $La/R \rightarrow 1$: avg. queueing delay large
- $La/R > 1$: more “work” arriving is more than can be serviced - average delay infinite!

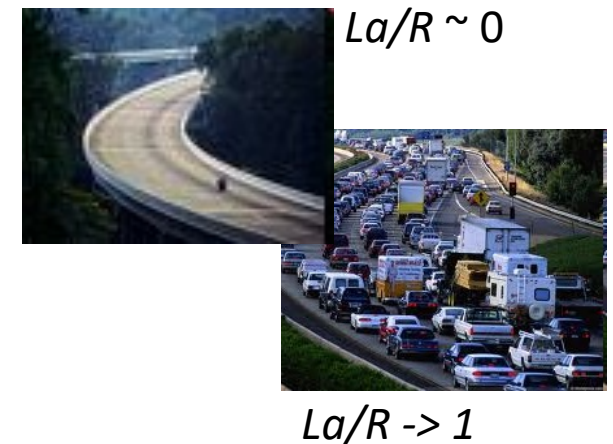
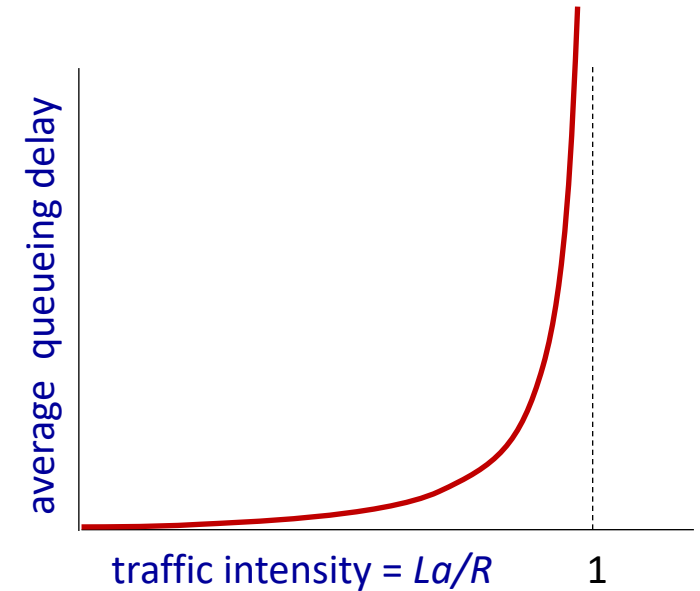

“Real” Internet delays and routes

- what do “real” Internet delay & loss look like?
- **traceroute** program: provides delay measurement from source to router along end-end Internet path towards destination. For all i :
 - sends three packets that will reach router i on path towards destination (with time-to-live field value of i)
 - router i will return packets to sender
 - sender measures time interval between transmission and reply

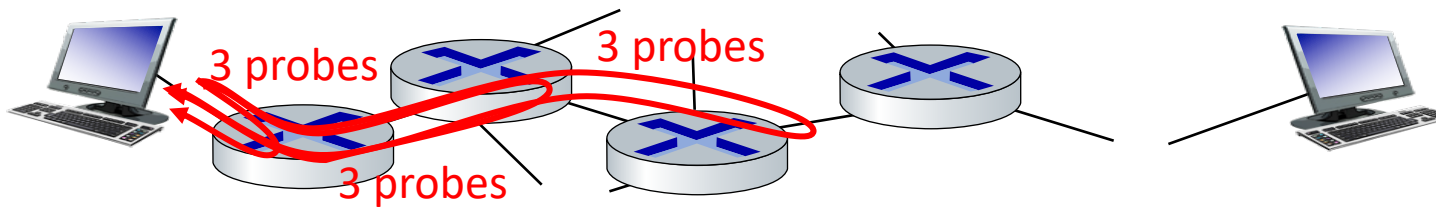

Real Internet delays and routes

traceroute: gaia.cs.umass.edu to www.eurecom.fr

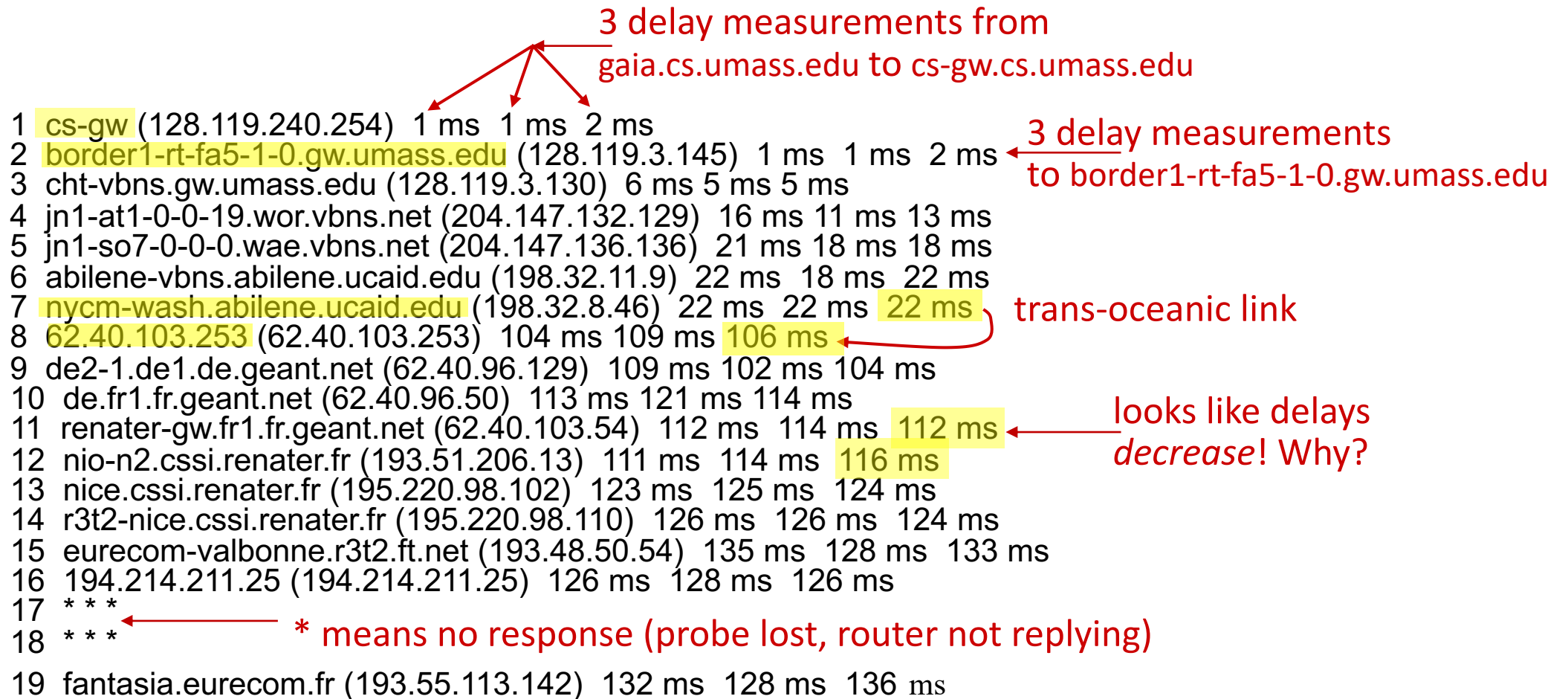

* Do some traceroutes from exotic countries at www.traceroute.org

Packet loss

- queue (aka buffer) preceding link in buffer has finite capacity
- packet arriving to full queue dropped (aka lost)
- lost packet may be retransmitted by previous node, by source end system, or not at all

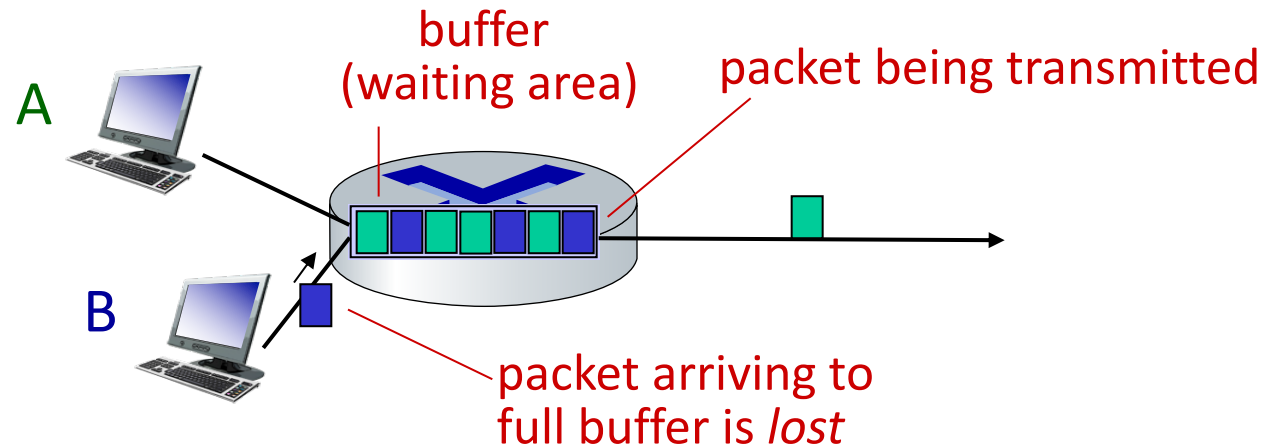

* Check out the Java applet for an interactive animation (on publisher's website) of queuing and loss

Throughput

- *throughput*: rate (bits/time unit) at which bits are being sent from sender to receiver
 - *instantaneous*: rate at given point in time
 - *average*: rate over longer period of time

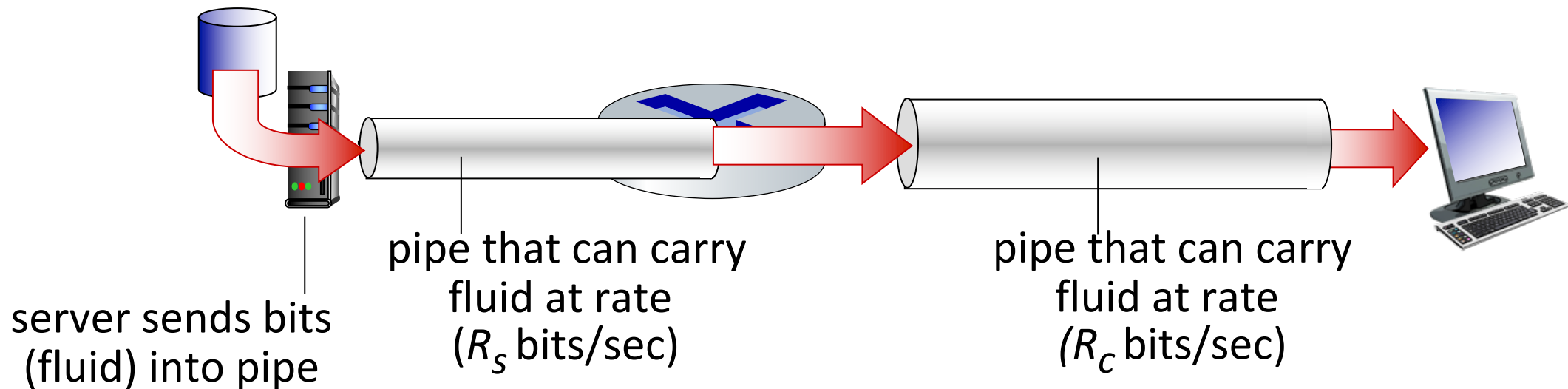

Throughput

$R_s < R_c$ What is average end-end throughput?

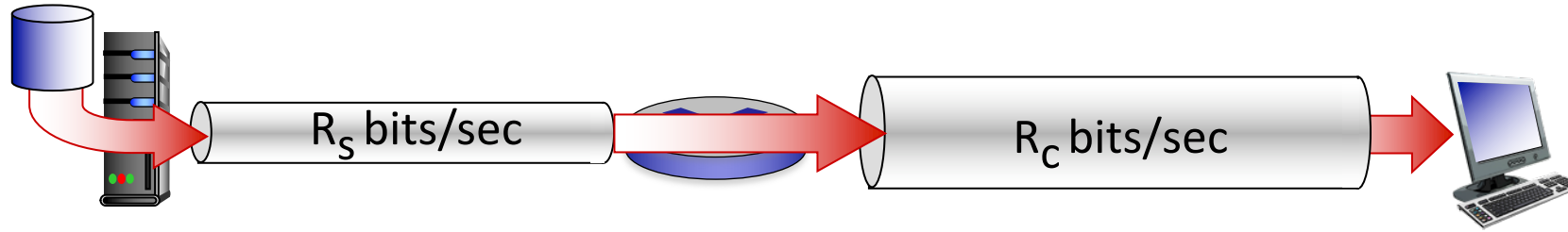

$R_s > R_c$ What is average end-end throughput?

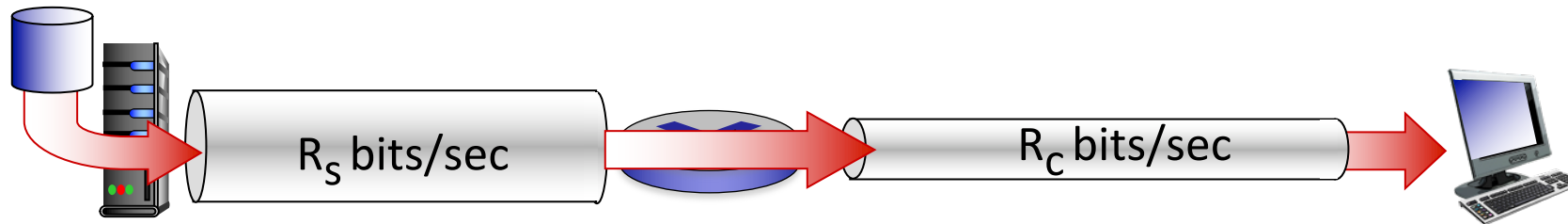

bottleneck link

link on end-end path that constrains end-end throughput

Throughput: network scenario

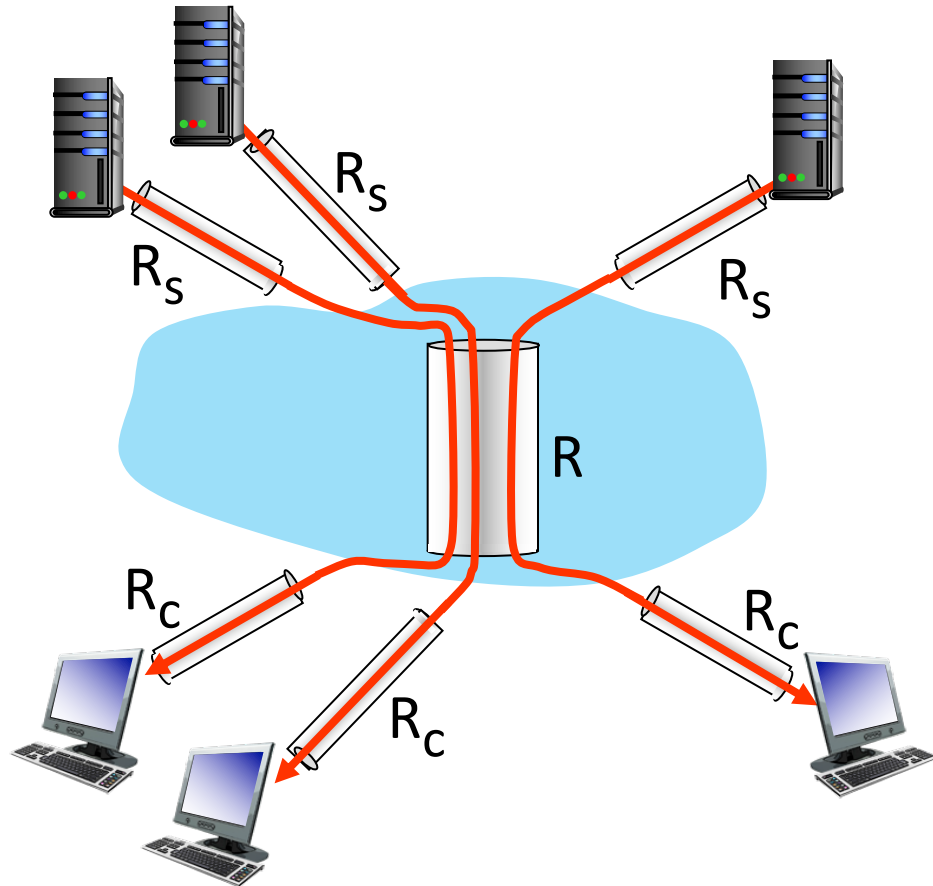

10 connections (fairly) share
backbone bottleneck link R bits/sec

- per-connection end-end throughput:
 $\min(R_c, R_s, R/10)$
- in practice: R_c or R_s is often bottleneck

* Check out the online interactive exercises for more examples: http://gaia.cs.umass.edu/kurose_ross/

Chapter 1: roadmap

- What *is* the Internet?
- What *is* a protocol?
- Network edge: hosts, access network, physical media
- Network core: packet/circuit switching, internet structure
- Performance: loss, delay, throughput
- **Security**
- Protocol layers, service models
- History



Network security

- Internet not originally designed with (much) security in mind
 - *original vision*: “a group of mutually trusting users attached to a transparent network” 😊
 - Internet protocol designers playing “catch-up”
 - security considerations in all layers!
- **We now need to think about:**
 - how bad guys can attack computer networks
 - how we can defend networks against attacks
 - how to design architectures that are immune to attacks

Network security

- Internet not originally designed with (much) security in mind
 - *original vision*: “a group of mutually trusting users attached to a transparent network” 😊
 - Internet protocol designers playing “catch-up”
 - security considerations in all layers!
- **We now need to think about:**
 - how bad guys can attack computer networks
 - how we can defend networks against attacks
 - how to design architectures that are immune to attacks

Bad guys: packet interception

packet "sniffing":

- broadcast media (shared Ethernet, wireless)
- promiscuous network interface reads/records all packets (e.g., including passwords!) passing by

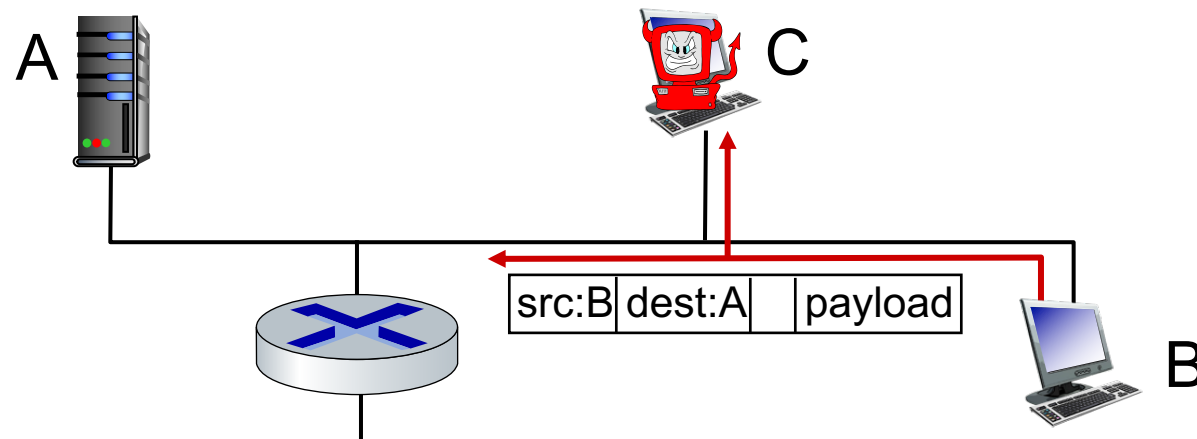

Wireshark software used for our end-of-chapter labs is a (free) packet-sniffer

Bad guys: fake identity

IP spoofing: injection of packet with false source address

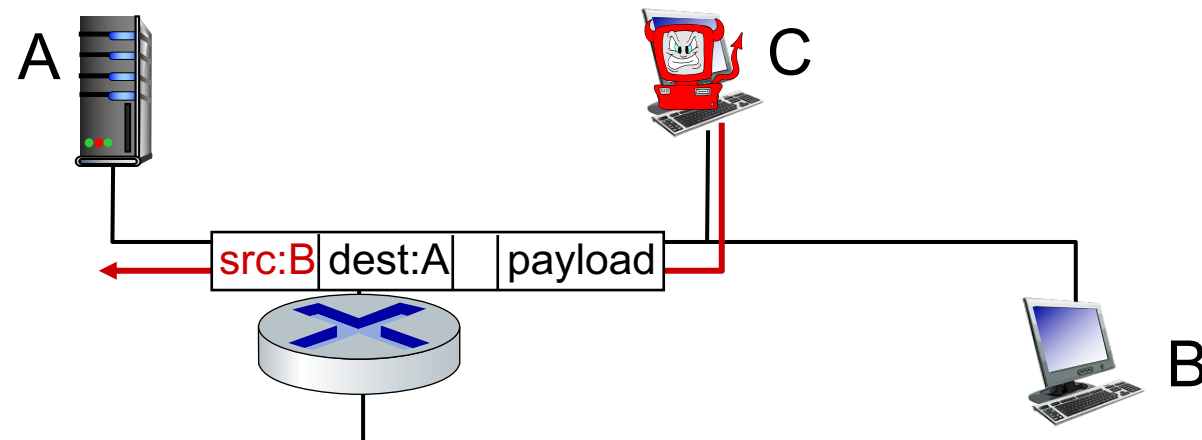

Bad guys: denial of service

Denial of Service (DoS): attackers make resources (server, bandwidth) unavailable to legitimate traffic by overwhelming resource with bogus traffic

1. select target
2. break into hosts around the network (see botnet)
3. send packets to target from compromised hosts

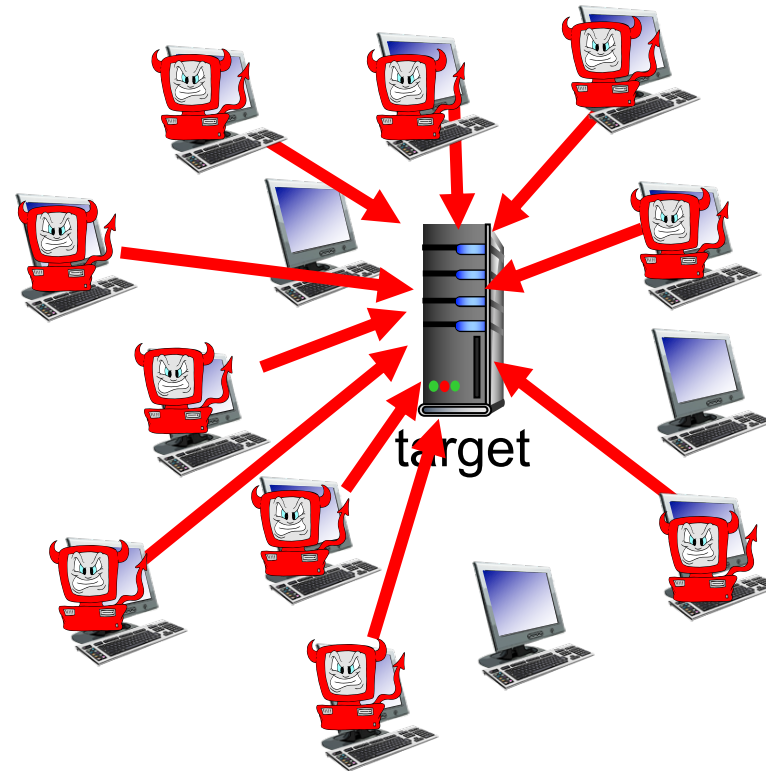

Lines of defense:

- **authentication:** proving you are who you say you are
 - cellular networks provides hardware identity via SIM card; no such hardware assist in traditional Internet
- **confidentiality:** via encryption
- **integrity checks:** digital signatures prevent/detect tampering
- **access restrictions:** password-protected VPNs
- **firewalls:** specialized “middleboxes” in access and core networks:
 - off-by-default: filter incoming packets to restrict senders, receivers, applications
 - detecting/reacting to DOS attacks

... lots more on security (throughout, Chapter 8)

Chapter 1: roadmap

- What *is* the Internet?
- What *is* a protocol?
- Network edge: hosts, access network, physical media
- Network core: packet/circuit switching, internet structure
- Performance: loss, delay, throughput
- Security
- **Protocol layers, service models**
- History



Protocol “layers” and reference models

Networks are complex,
with many “pieces”:

- hosts
- routers
- links of various media
- applications
- protocols
- hardware, software

Question: is there any
hope of *organizing*
structure of network?

- and/or our *discussion*
of networks?

Example: organization of air travel



————— *end-to-end transfer of person plus baggage* —————>

ticket (purchase)

baggage (check)

gates (load)

runway takeoff

airplane routing

ticket (complain)

baggage (claim)

gates (unload)

runway landing

airplane routing

airplane routing

How would you *define/discuss* the *system* of airline travel?

- a series of steps, involving many services

Example: organization of air travel



layers: each layer implements a service

- via its own internal-layer actions
- relying on services provided by layer below

Why layering?

Approach to designing/discussing complex systems:

- explicit structure allows identification, relationship of system's pieces
 - layered *reference model* for discussion
- modularization eases maintenance, updating of system
 - change in layer's service *implementation*: transparent to rest of system
 - e.g., change in gate procedure doesn't affect rest of system

Layered Internet protocol stack

- ***application***: supporting network applications
 - HTTP, IMAP, SMTP, DNS
- ***transport***: process-process data transfer
 - TCP, UDP
- ***network***: routing of datagrams from source to destination
 - IP, routing protocols
- ***link***: data transfer between neighboring network elements
 - Ethernet, 802.11 (WiFi), PPP
- ***physical***: bits “on the wire”

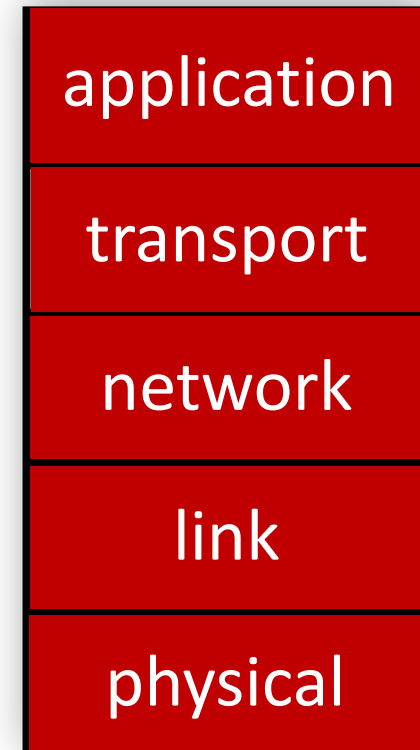

Services, Layering and Encapsulation

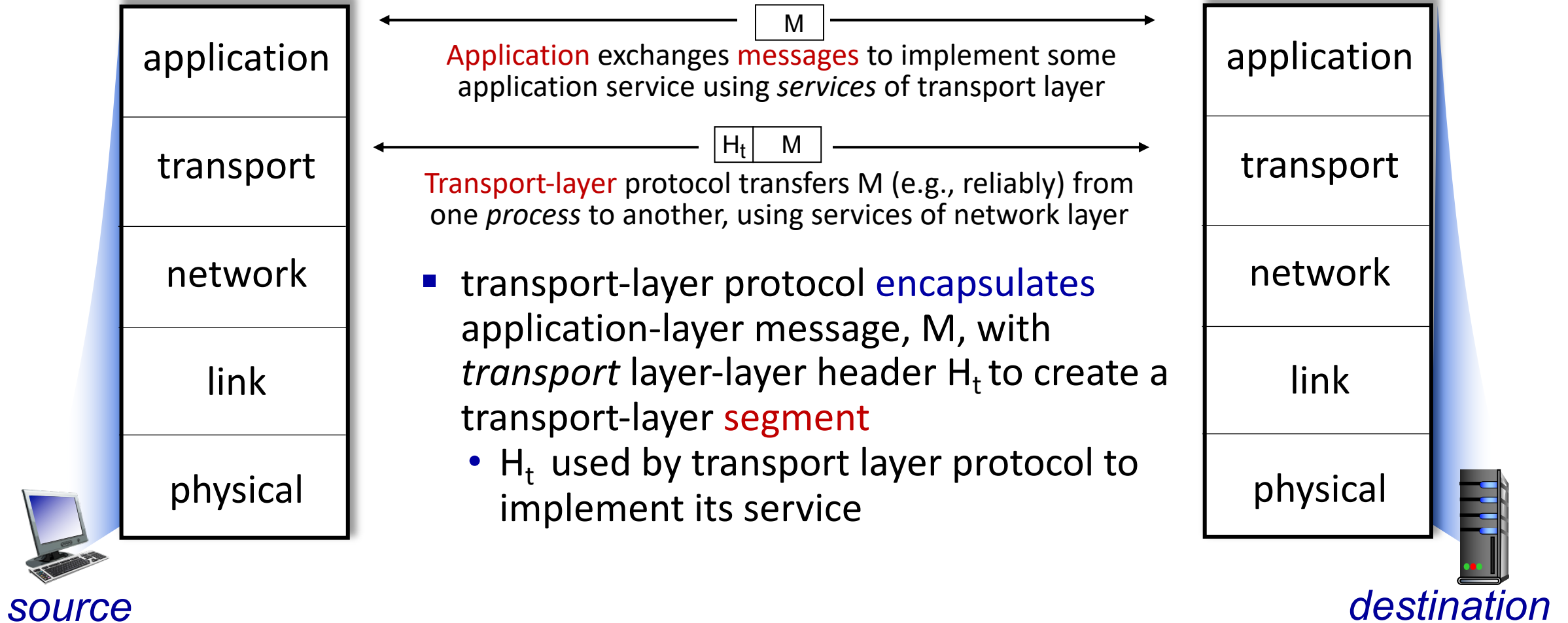

Services, Layering and Encapsulation

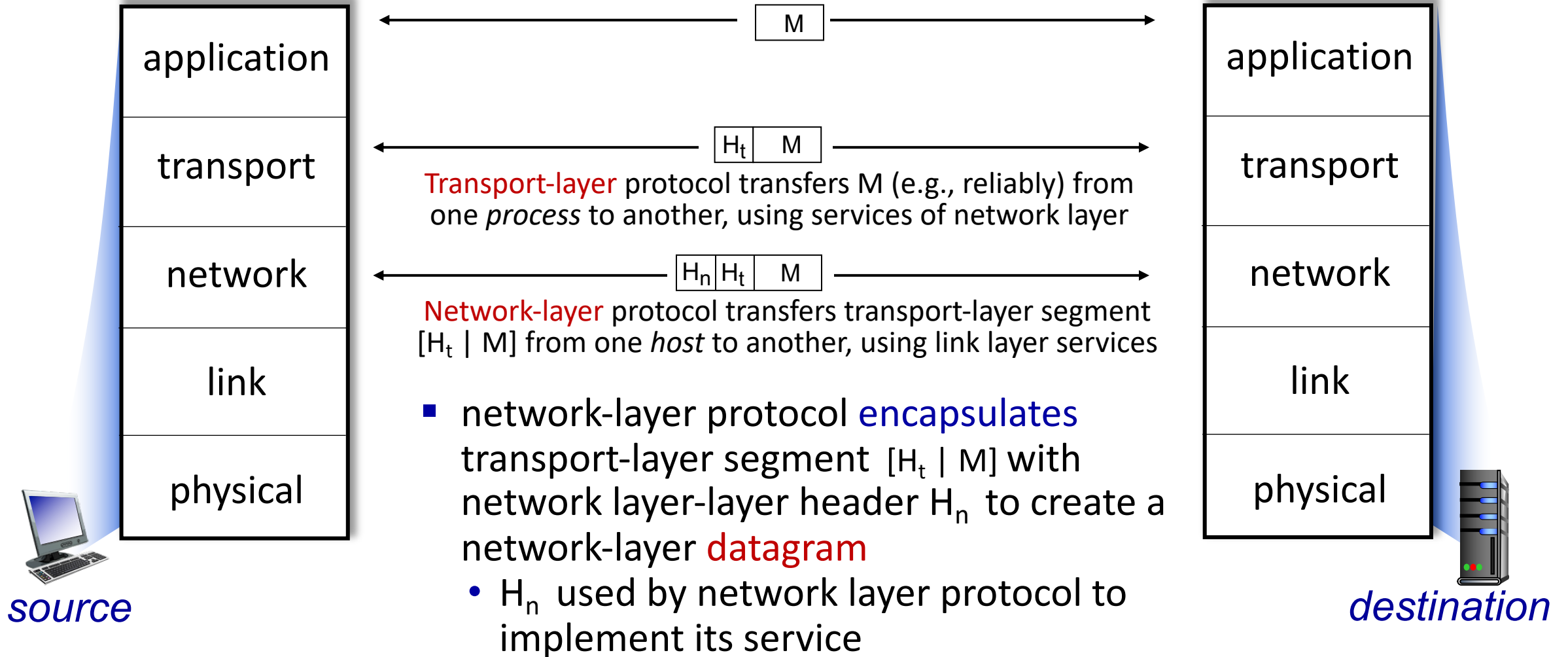

Services, Layering and Encapsulation

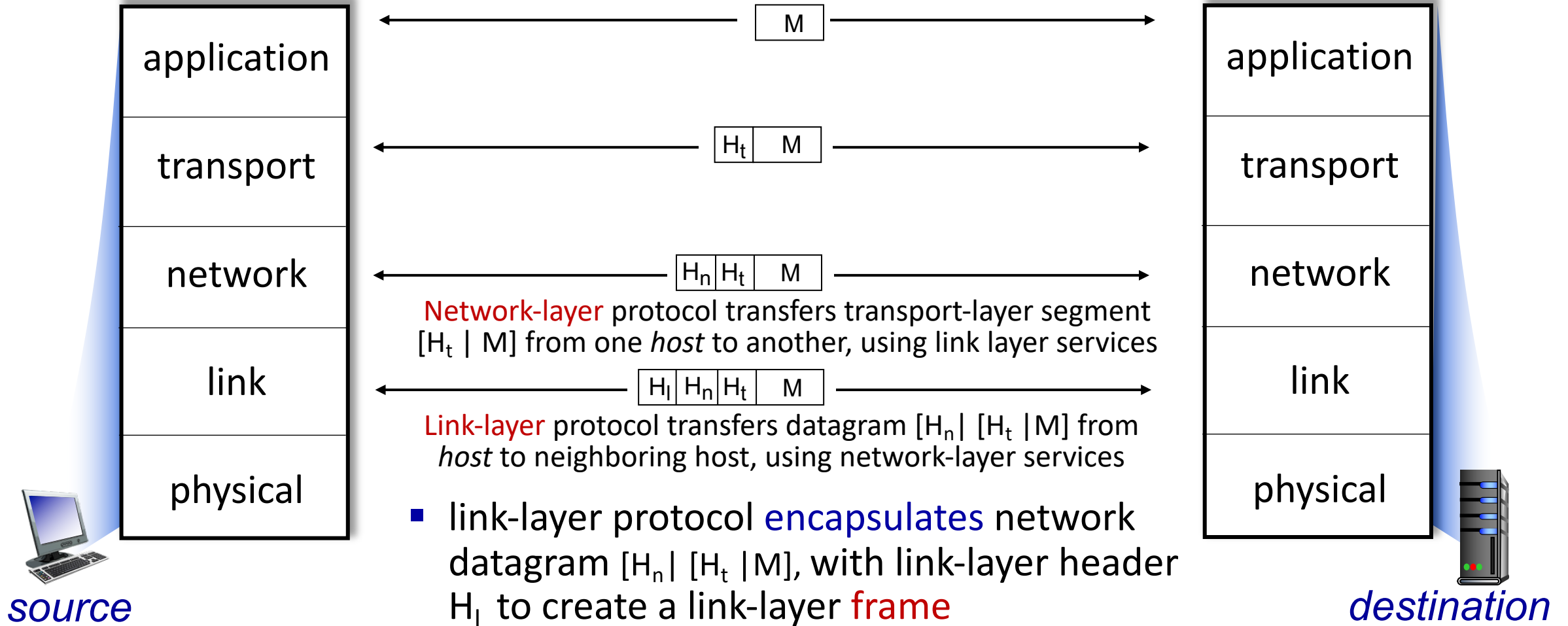

Services, Layering and Encapsulation

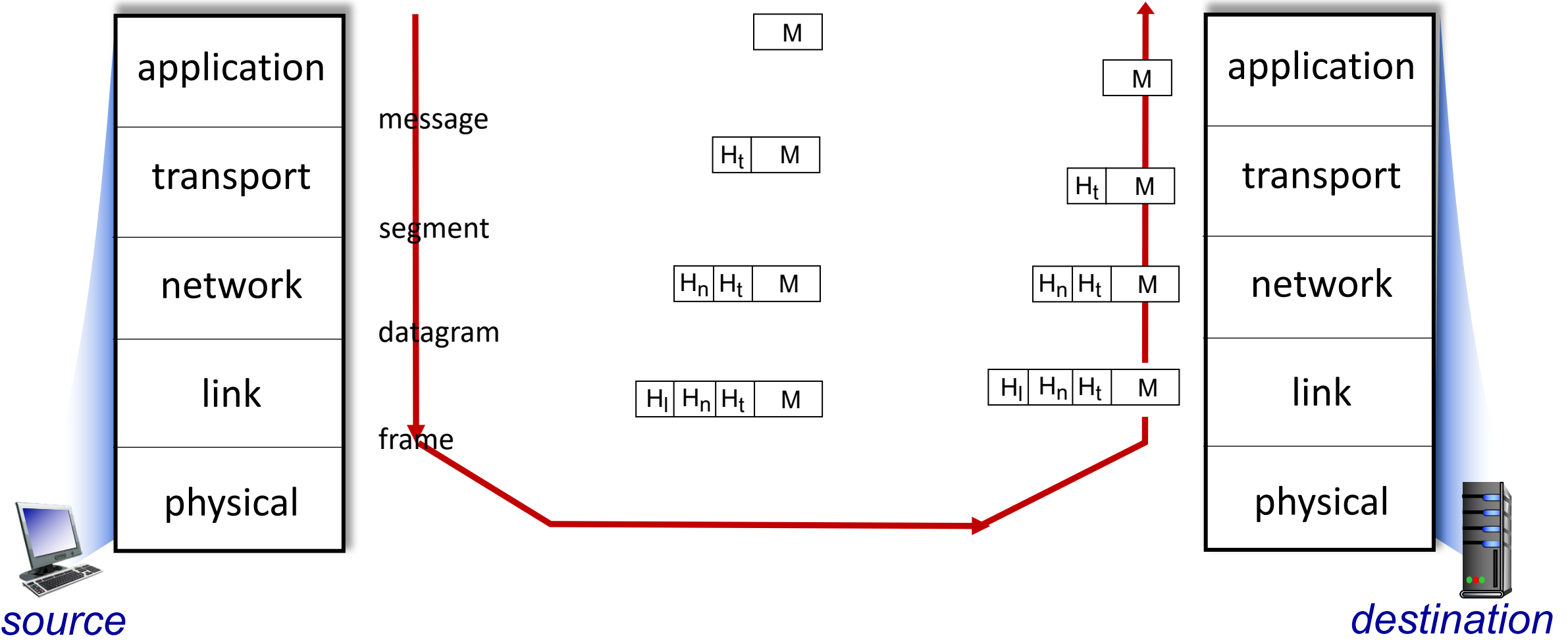

Encapsulation: an end-end view

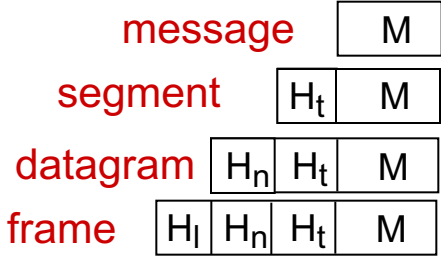

source

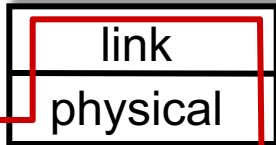
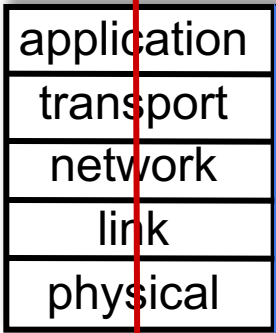

switch

destination

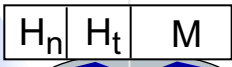
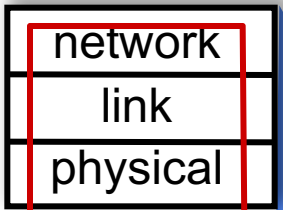
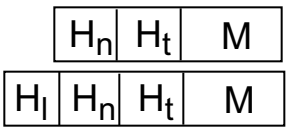
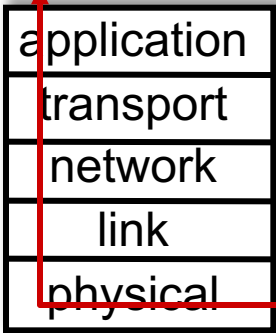
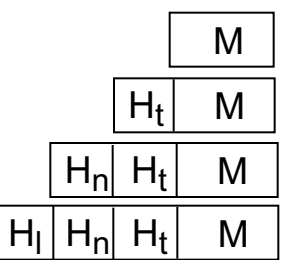

router

Chapter 1: roadmap

- What *is* the Internet?
- What *is* a protocol?
- Network edge: hosts, access network, physical media
- Network core: packet/circuit switching, internet structure
- Performance: loss, delay, throughput
- Security
- Protocol layers, service models
- **History**



Internet history

1961-1972: Early packet-switching principles

- **1961:** Kleinrock - queueing theory shows effectiveness of packet-switching
- **1964:** Baran - packet-switching in military nets
- **1967:** ARPAnet conceived by Advanced Research Projects Agency
- **1969:** first ARPAnet node operational
- **1972:**
 - ARPAnet public demo
 - NCP (Network Control Protocol) first host-host protocol
 - first e-mail program
 - ARPAnet has 15 nodes

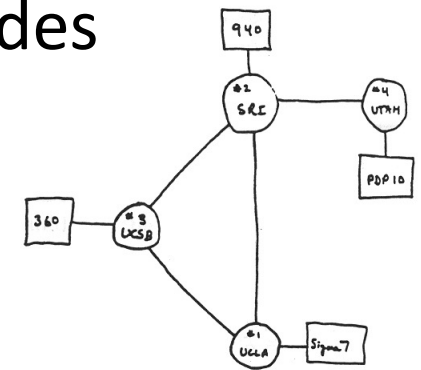

THE ARPA NETWORK

Internet history

1972-1980: Internetworking, new and proprietary networks

- **1970:** ALOHAnet satellite network in Hawaii
- **1974:** Cerf and Kahn - architecture for interconnecting networks
- **1976:** Ethernet at Xerox PARC
- **late70's:** proprietary architectures: DECnet, SNA, XNA
- **1979:** ARPAnet has 200 nodes

Cerf and Kahn's internetworking principles:

- minimalism, autonomy - no internal changes required to interconnect networks
- best-effort service model
- stateless routing
- decentralized control

define today's Internet architecture

Internet history

1980-1990: new protocols, a proliferation of networks

- 1983: deployment of TCP/IP
- 1982: smtp e-mail protocol defined
- 1983: DNS defined for name-to-IP-address translation
- 1985: ftp protocol defined
- 1988: TCP congestion control
- new national networks: CSnet, BITnet, NSFnet, Minitel
- 100,000 hosts connected to confederation of networks

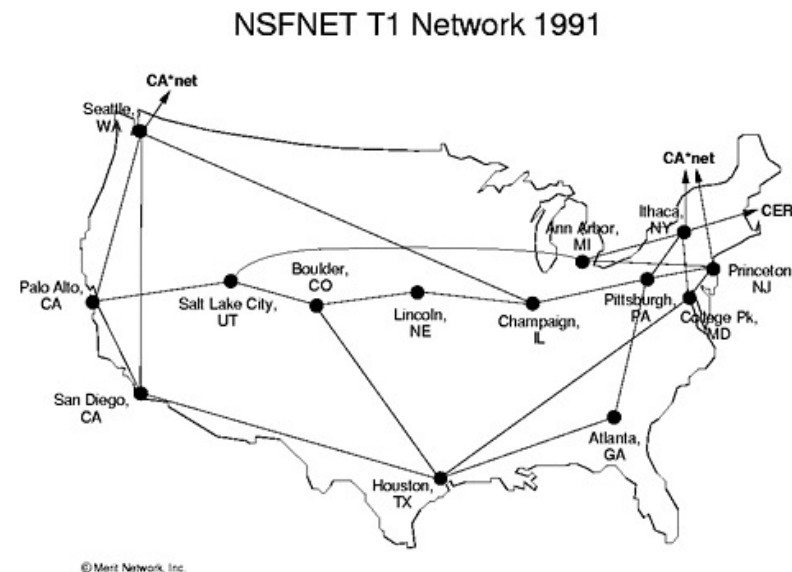

Internet history

1990, 2000s: commercialization, the Web, new applications

- early 1990s: ARPAnet decommissioned
- 1991: NSF lifts restrictions on commercial use of NSFnet (decommissioned, 1995)
- early 1990s: Web
 - hypertext [Bush 1945, Nelson 1960's]
 - HTML, HTTP: Berners-Lee
 - 1994: Mosaic, later Netscape
 - late 1990s: commercialization of the Web
- late 1990s – 2000s:
 - more killer apps: instant messaging, P2P file sharing
 - network security to forefront
 - est. 50 million host, 100 million+ users
 - backbone links running at Gbps

Internet history

2005-present: scale, SDN, mobility, cloud

- aggressive deployment of broadband home access (10-100's Mbps)
- 2008: software-defined networking (SDN)
- increasing ubiquity of high-speed wireless access: 4G/5G, WiFi
- service providers (Google, FB, Microsoft) create their own networks
 - bypass commercial Internet to connect “close” to end user, providing “instantaneous” access to social media, search, video content, ...
- enterprises run their services in “cloud” (e.g., Amazon Web Services, Microsoft Azure)
- rise of smartphones: more mobile than fixed devices on Internet (2017)
- ~18B devices attached to Internet (2017)

Chapter 1: summary

We've covered a "ton" of material!

- Internet overview
- what's a protocol?
- network edge, access network, core
 - packet-switching versus circuit-switching
 - Internet structure
- performance: loss, delay, throughput
- layering, service models
- security
- history

You now have:

- context, overview, vocabulary, "feel" of networking
- more depth, detail, *and fun* to follow!

Additional Chapter 1 slides

ISO/OSI reference model

Two layers not found in Internet protocol stack!

- *presentation*: allow applications to interpret meaning of data, e.g., encryption, compression, machine-specific conventions
- *session*: synchronization, checkpointing, recovery of data exchange
- Internet stack “missing” these layers!
 - these services, *if needed*, must be implemented in application
 - needed?

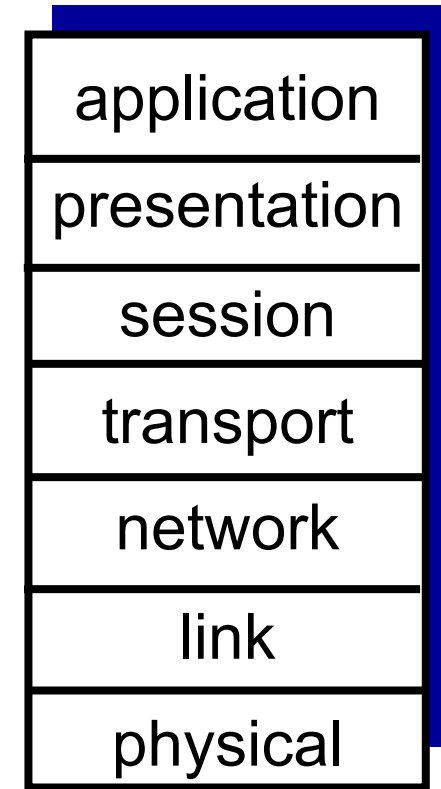

The seven layer OSI/ISO reference model

Wireshark

